

## Collections

Captain Heaven  
Captain Join  
Captain Line  
Captain Lounge  
Captain Play  
Captain Welcome  
Diamond Evo  
Factory  
Frame Evo  
Libro  
More  
Multitask  
Stay  
Use Me  
We Meet  
Vogue

SINETICA

Scrivanie direzionali, Executive desks, Bureaux e direction, Escritorios direccionales, Chefbüros, Столы для руководителя	Scrivanie operative, Modular desks, Bureaux fonctionnels, Zusammenstellbare Schreibtische, Escritori direccionales, Столы для персонала	Contenitori e librerie, Cabinets & bookcases, Rangements & librairies, Schraenken & Regalen, Contenedores y librerías, Шкафы и стеллажи	Sedute, Seating, Sièges, Stühle, Asientos, Стулья и кресла	Divani e poltrone, Sofas and armchairs, Canapés et fauteuils, Couches und Bummelant, Sofás y sillones, Мягкая мебель	Tavoli riunione, Meeting tables, Tables de réunion, Besprechungstische, Mesasde reunión, Столы для переговоров	Tavolini, Coffee tables, Tables basses, Couchtische, Mesas de café, Столики	Reception, Reception counter, Banque réception, Empfangstheke, Mostrador de resepcción, Ресепшен
· <b>Diamond</b> 84 Executive, Meeting, Operative, Smart Working, Welcome	· <b>Diamond</b> 44, 46, 84 Executive, Meeting, Operative, Smart Working, Welcome	· <b>Libro</b> 152 Executive, Operative, Smart Working	· <b>Captain Line</b> 6, 166 Executive, Meeting, Operative	· <b>Captain Heaven</b> 30, 50, 176 Executive, Welcome	· <b>Diamond</b> 55, 84 Executive, Meeting, Operative, Smart Working	· <b>Multitask</b> 72, 190 Smart Working, Welcome	· <b>Factory</b> 18, 28, 50, 194 Welcome
· <b>Frame</b> 6, 96 Executive, Meeting, Operative, Smart Working	· <b>Frame</b> 11, 74, 96 Executive, Meeting, Operative, Smart Working	· <b>Use Me</b> 3, 14, 48, 66, 142 Meeting, Operative, Smart Working, Welcome	· <b>Captain Play</b> 48, 160 Meeting, Operative, Smart Working, Welcome	· <b>Captain Join</b> 3, 14, 182 Executive, Meeting, Welcome	· <b>Frame</b> 4, 69, 78, 96 Executive, Meeting, Operative, Smart Working		
· <b>More</b> 33, 136 Executive	· <b>Stay</b> 59, 106 Executive, Meeting, Operative, Smart Working			· <b>Captain Lounge</b> 186 Executive, Welcome	· <b>Stay</b> 64, 106 Executive, Meeting, Operative, Smart Working		
· <b>Stay</b> 26, 106 Executive, Meeting, Operative, Smart Working	· <b>We Meet</b> 36, 40, 120 Executive, Meeting, Operative, Smart Working			· <b>Captain Welcome</b> 16, 30, 170 Executive, Welcome	· <b>We Meet</b> 120 Executive, Meeting, Operative, Smart Working		
· <b>Vogue</b> 130 Executive							

# General catalogue

Sostenibilità, benessere, capacità di creare relazioni, scambi e condivisioni: questi sono requisiti fondamentali di uno spazio architettonico dedicato allo smart working.





IT · Scrivania Frame, sedie  
Captain Line.

EN · Frame desk, Captain Line  
chairs.



IT · Scrivania Frame, sedie Captain Line Soft.

EN · Frame desk, Captain Line Soft chairs.



IT · Scrivania Frame, sedie Captain Line Soft, poltrona Captain Heaven Soft.

EN · Frame desk, Captain Line Soft chairs, Captain Heaven Soft armchair.

IT · Scrivanie Frame con Aluscreen. EN · Frame benches with Aluscreen.









IT · Librerie e contenitori panca  
Use Me, poltrone Captain Join.

EN · Use Me bookcases and  
cabinets, Captain Join armchairs.



IT · Poltrone e divani Captain Welcome.

EN · Captain Welcome armchairs and sofas.



IT · Reception Factory, poltrone  
Captain Welcome.

EN · Factory reception, Captain  
Welcome armchairs.



Un open space dove si alternano momenti di concentrazione, incontro e collaborazione, con piacevoli richiami al mondo domestico.

IT · Scrivanie Stay con contenitori Use Me, librerie Use Me, sedie Captain Play.

EN · Stay desks with Use Me storage units, Use Me bookcases, Captain Play chairs.







IT · Scrivanie Stay con contenitori Use Me, librerie Use Me, sedie Captain Play.

EN · Stay desks with Use Me storage units, Use Me bookcases, Captain Play chairs.





IT · Reception Factory e tavolini Multitask.

EN · Factory reception, Multitask coffee tables.



IT · Poltrona Captain Heaven Soft, divano e poltrone Captain Welcome.

EN · Captain Heaven Soft armchair, Captain Welcome sofa and armchairs.

Il valore dello spazio risiede anche nella sua capacità di suscitare emozioni, raccontando una storia di successo attraverso l'uso di materiali prestigiosi.



IT · Scrivania More, sedie Captain Line Soft e Captain Play.

EN · More desk, Captain Line Soft and Captain Play chairs.





IT · Moduli We Meet, scrivanie Diamond.

EN · We Meet modules, Diamond benches.



IT · Moduli We Meet, scrivanie Diamond con screen e contenitori Use Me, sedie Captain Play, librerie Libro.

EN · We Meet modules, Diamond benches with screen and Use Me storage units, Captain Play chairs, Libro bookcases.

IT · Moduli We Meet,  
contenitori Use Me, sedie Captain Play.

EN · We Meet modules,  
Use Me cabinets, Captain Play chairs.



La privacy e la comunicazione sono due aspetti complementari, in un ambiente che accoglie tutte le esigenze dei singoli e del gruppo.







IT · Scrivanie Diamond con screen e contenitori Use Me, sedie Captain Play, moduli We Meet.

EN · Diamond benches with screen and Use Me storage units, Captain Play chairs, We Meet modules.



IT · Scrivanie Diamond.

EN · Diamond benches.



IT · Scrivanie Diamond con screen e contenitori Use Me, sedie Captain Play.

EN · Diamond benches with screen and Use Me storage units, Captain Play chairs.



IT - Reception Factory, poltrone  
Captain Heaven

FN - Factory reception, Captain  
Heaven armchairs



IT · Reception Factory, poltrone Captain Heaven.

EN · Factory reception, Captain Heaven armchairs.

L'architettura del passato  
incontra i modelli culturali  
e di business del presente,  
dando vita a una sintesi  
eclettica e personale.



IT · Tavolo Diamond, contenitori  
Use Me.

EN · Diamond meeting table,  
Use Me cabinets.



IT · Tavolo Diamond, contenitori Use Me.

EN · Diamond meeting table, Use Me cabinets.

Interazione e convivialità, idee ed energie in libera circolazione, piante che contribuiscono a creare un'atmosfera salubre e positiva.

IT · Scrivanie Stay con screen, sedie Captain Play.

EN · Stay benches with screen, Captain Play chairs.







IT · Scrivanie Stay con screen, sedie Captain Play.

EN · Stay benches with screen, Captain Play chairs.



IT · Scrivanie Stay con screen, sedie Captain Play.

EN · Stay benches with screen, Captain Play chairs.



IT · Tavolo Stay, sedie Captain Play.

EN · Stay meeting table, Captain Play chairs.



IT · Tavolo Stay, sedie Captain Play, librerie Wire, contenitori Use Me.

EN · Stay meeting table, Captain Play chairs, Wire bookcases, Use Me cabinets.

IT · Tavolo Frame convivial, sgabelli  
e sedia Captain Play.

EN · Frame convivial table, Captain  
Play chair and stools.

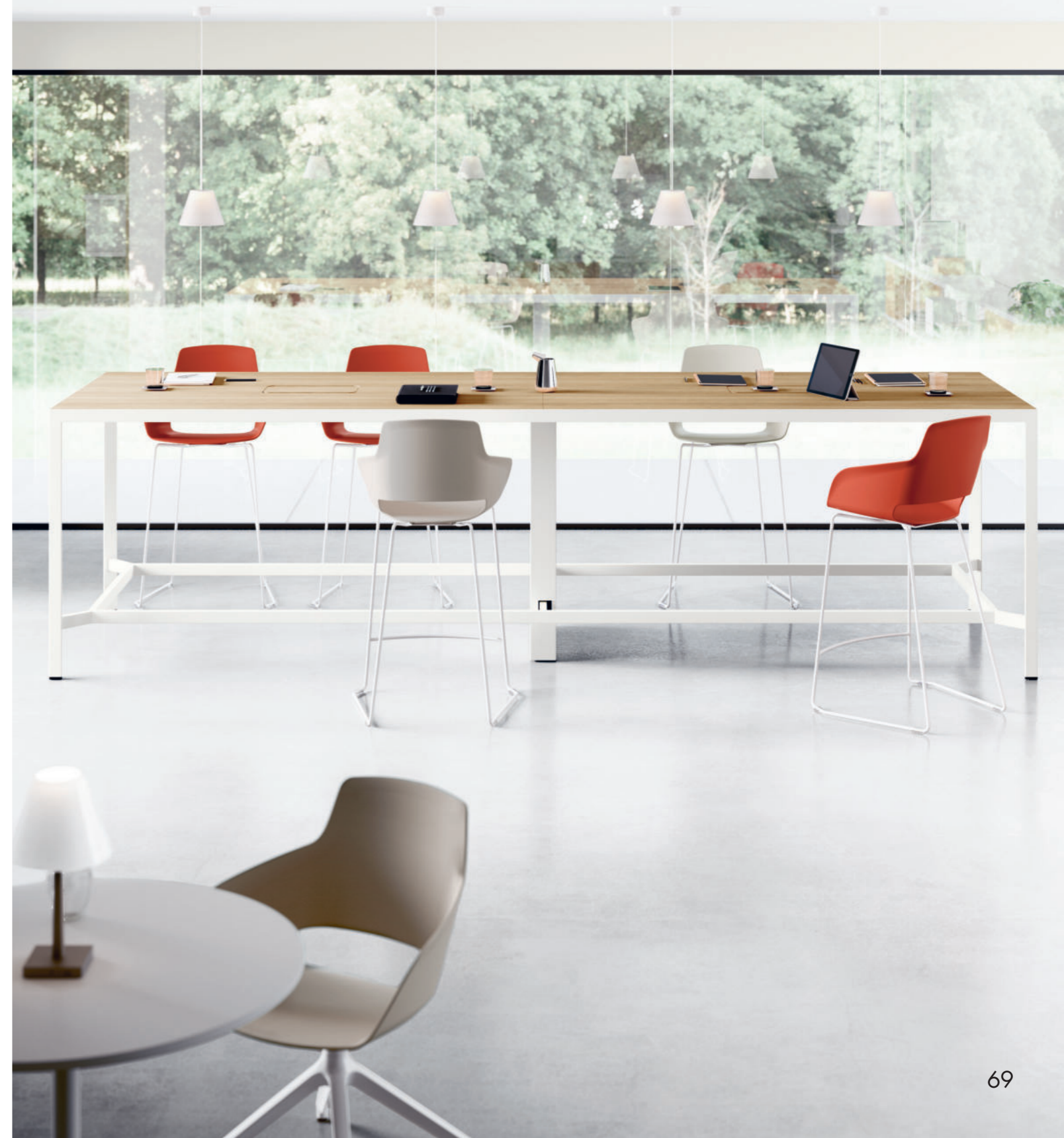



IT · Tavolo Frame convivial, tavolini Multitask, sedie e sgabelli Captain Play.

EN · Frame Convivial table, Multitask tables, Captain Play chairs and stools.



IT · Tavolini Multitask, sedie e sgabelli Captain Play.

EN · Multitask tables, Captain Play chairs and stools.



IT · Scrivanie Frame con screen, contenitori Use Me.

EN · Frame benches with screen, Use Me cabinets.



L'evoluzione del mondo in cui viviamo porta alla creazione di spazi ibridi, senza barriere fisiche, concettuali o gerarchiche.



IT · Scrivania Frame con screen, contenitori Use Me.

EN · Frame benches with screen, Use Me cabinets.



IT · Tavolo Frame, sedie Captain Play.

EN · Frame meeting table, Captain Play chairs.



IT · Tavolo Frame, sedie Captain Play.

EN · Frame meeting table, Captain Play chairs.



Captain Heaven	176
Captain Join	182
Captain Line	166
Captain Lounge	186
Captain Play	160
Captain Welcome	170
Diamond	84
Factory	194
Frame	96
Libro	152
More	136
Multitask	190
Stay	106
Use Me	142
We Meet	120
Vogue	130

# Diamond Collection

by Hangar Design Group

Sinetica

IT · Linee geometriche per una scrivania versatile caratterizzata dalla gamba con forma triangolare in grado di generare composizioni sempre nuove e capaci di catturare l'attenzione. Il punto di partenza per composizioni modulari, una solida base per l'ufficio che vuole sfruttare al meglio i propri spazi.

EN · Its geometric lines turn Diamond into a versatile desk characterized by a triangular-shaped leg which is able to create new eye-catching compositions. This is the ideal starting point for modular compositions, as well as a solid base to best fill out the space in the office.

FR · Des lignes géométriques pour un bureau polyvalent caractérisé par un pied de section triangulaire. Possibilité de créer des compositions toujours nouvelles pour se démarquer. Le point de départ des compositions modulaires, une base solide pour le bureau qui veut tirer le meilleur parti de ses espaces.

DE · Seine geometrischen Linien machen Diamond zu einem vielseitigen Schreibtisch, der durch ein dreieckiges Bein charakterisiert wird, das neue auffällige Kompositionen kreieren kann. Dies ist der ideale Ausgangspunkt für modulare Kompositionen und eine solide Basis, um den Raum im Büro optimal auszufüllen.

ES · Líneas geométricas para un escritorio versátil caracterizado por patas triangulares. Posibilidad de crear composiciones nuevas y capaces de atraer la atención. Es el punto de partida para composiciones modulares, una base sólida para oficina que aprovecha al máximo el espacio.

RU · Геометрические линии для универсального письменного стола, характеризующегося ножкой треугольной формы, способной создавать все новые и новые композиции, способные привлечь внимание. Отправная точка для модульных композиций - прочная основа для офиса, который хочет максимально использовать свое пространство.



TYPE: Bench (h. 74 cm)

## Diamond Collection

IT · L'inconfondibile struttura con profilo triangolare di Diamond mostra finiture brillantemente glamour o raffinatamente chic per interpretare l'ambiente executive con versatilità e personalità.

EN · The unique structure of Diamond, with its peculiar triangular profile, sports glamorous and fancy finishes, making the environment versatile with a customised touch.

FR · La structure triangulaire reconnaissable du Diamond offre des finitions glamour ou chic permettant polyvalence ou personnalisation de l'environnement de travail.

DE · Die einzigartige Struktur des Diamond mit seinem besonderen dreieckigen Profil, sportlichen Glamour und ausgefallenen Oberflächen, macht die Umgebung vielseitig und bietet eine individuelle.

ES · La inconfundible estructura con perfil triangular de Diamond ofrece acabados glamour o chic, lo que permite su adaptación a un ambiente ejecutivo con versatilidad y personalidad.

RU · Уникальная треугольная форма опор коллекции Diamond подчеркивает изысканное исполнение и инновационный дизайн, придающий кабинету универсальность и динамичную индивидуальность.

TYPE: Desk (h. 74 cm)



## Diamond Collection

IT · Workstations e bench, doppi o singoli: soluzioni per vivere e condividere i valori funzionali e architettonici attuali in un ambiente di lavoro contemporaneo.

EN · Workstations and benches, either double or single, become ways to explore the latest aesthetic, functional and architectural values of the contemporary work environment.

FR · Postes de travail face à face ou en ligne: des solutions pour vivre et partager les valeurs fonctionnelles et architecturales dans un environnement de travail contemporain.

DE · Doppel - oder Einzelarbeitsplätze und Bänke bieten die Möglichkeit, die neuesten ästhetischen, funktionalen und architektonischen Werte der modernen Arbeitsumgebung zu erkunden.

ES · Mesas de trabajo y bancos, dobles o individuales: soluciones para vivir y compartir los valores funcionales y arquitectónicos actuales en un ambiente de trabajo contemporáneo.

RU · Рабочие места и скамьи, двойные или одиночные: решения для жизни и обмена текущими функциональными и архитектурными ценностями в современной рабочей среде.

TYPE: Hub (h. 74 cm)







TYPE: Meeting (h. 74 cm)

IT · Lo spessore sottile dei piani aggiunge un tocco di raffinata eleganza, permettendo i più diversi abbinamenti. Tutto questo si unisce alla versatilità compositiva di un sistema trasversale, creato per dare un nuovo stile al lavoro contemporaneo.

EN · The touch of elegance given by the thin desk, which allows the most different combinations, mingles with the versatility of the cross system, designed to give a new style to the contemporary work.

FR · La fine épaisseur des plateaux ajoute une touche d'élégance, combinée avec la modularité d'un système transversal, crée pour offrir un nouveau style au travail contemporain.

DE · Die Eleganz, die durch den dünnen Schreibtisch, der die unterschiedlichsten Kombinationen ermöglicht, gegeben wird, mischt sich mit der Vielseitigkeit des Kreuzsystems, das der zeitgenössischen Arbeit einen neuen Stil verleiht.

ES · El sutil grosor de las superficies confiere un toque de elegancia y permiten gran cantidad de combinaciones. Esto unido a la versatilidad de un sistema modular, proporciona un nuevo estilo a los ambientes de trabajo contemporáneos.

RU · Тонкие шпонируемые столешницы приносят элегантность и позволяют обеспечить различные сочетания материалов. Всё это, наряду с возможностью дополнения письменного стола приставкой, предназначено для придания качественно нового стиля современному рабочему месту.



1 IT *Gamba rientrante*  
 EN *Recessed leg*  
 FR *Piédement en retrait*  
 DE *Abgesetztes Bein*  
 ES *Pata escamoteable*  
 RU *Встраиваемая нога*

2 IT *Cablaggio*  
 EN *Wiring*  
 FR *Bac à câbles sous plateau*  
 DE *Verkabelung*  
 ES *Cablaje*  
 RU *Проводка*

3 IT *Asola passacavi centrale*  
 EN *Central scallop*  
 FR *Défonçage centrale sur le plateau*  
 DE *Mittig Kabel-Loch*  
 ES *Ojal pasacable cenral*  
 RU *Центральная прорезь для кабеля*

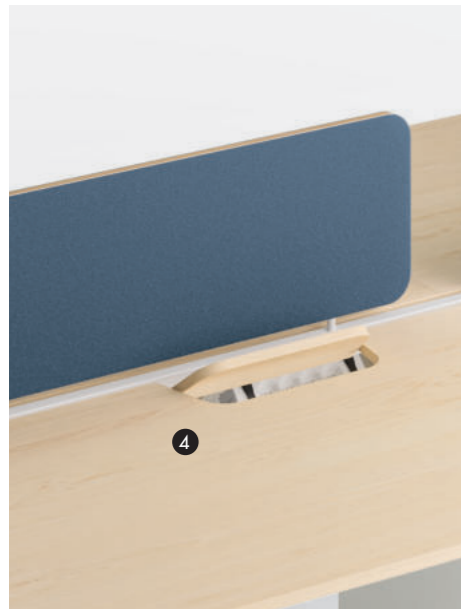

4 IT *Flap in finitura piano*  
 EN *Flap with same finish as the desk top*  
 FR *FLAP en teinte avec le plateau*  
 DE *Flap mit gleichen Tisch-Farbe*  
 ES *Tapa con mismo acabado del escritorio*  
 RU *Заглушка в цвет стола*

5 IT *Top access*  
 EN *Top access*  
 FR *Top accès*  
 DE *Klappe*  
 ES *Tapa registrable*  
 RU *Заглушка в цвет стола*

6 IT *Kit staffe porta prese*  
 EN *Brackets kit to carry electrical socket*  
 FR *Fixations support prises au-dessus du plateau pour bench*  
 DE *Obere Steckdose-kit*  
 ES *Caja electrica superior*  
 RU *Комплект подразетников*

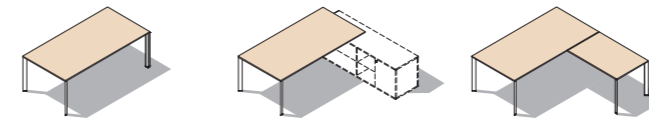

Desk  
 W 120 / 140 / 160 / 180 / 200  
 D 80 / 100 - H 74

integrabile con  
 contenitori Use  
 Me / can be  
 integrated with  
 Use Me cabinets

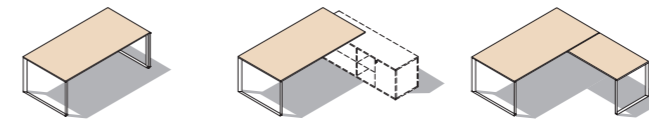

W 120 / 140 / 160 / 180 / 200  
 D 80 / 100 - H 74

integrabile con  
 contenitori Use  
 Me / can be  
 integrated with  
 Use Me cabinets

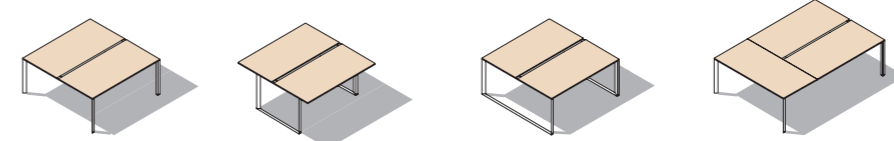

Bench  
 W 120 / 140 / 160 / 180 / 200  
 D 165 - H 74      W 160 / 180 / 200  
 D 165 - H 74      W 120 / 140 / 160 / 180 / 200  
 D 165 - H 74      W 200 / 220 / 240  
 D 165 - H 74

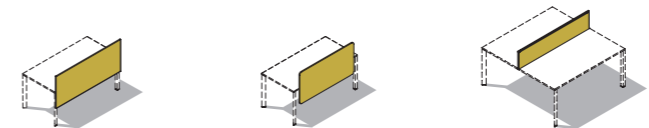

Screen  
 W 120 / 140 / 160 / 180 / 200  
 D 1,8 - H 68,5 / 70,3      W 96 / 116 / 136 / 156 / 176  
 D 1,8 - H 69      W 120 / 140 / 160 / 180 / 200  
 D 1,8 - H 31,1 / 32,9 / 35,3 / 37,1

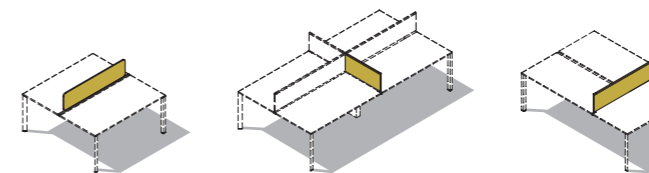

W 100 / 140 / 160 / 180  
 D 1,8 - H 36      W 80  
 D 1,8 - H 32,9 / 37,1      W 160  
 D 1,8 - H 31,1 / 32,9 / 35,3 / 37,1

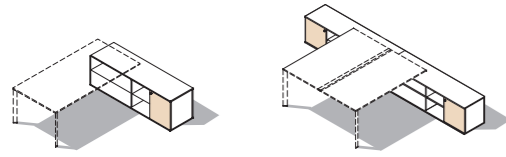

Hub

W 180  
D 46 - H 54,5

W 360  
D 46 - H 54,5

integrabile con  
contenitori Use  
Me / can be  
integrated with  
Use Me cabinets

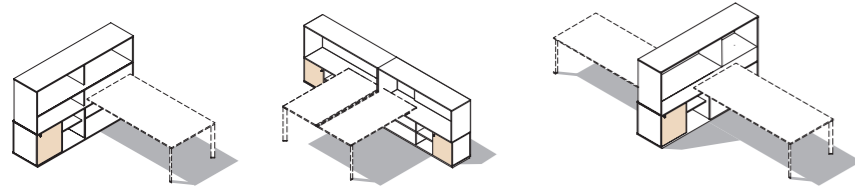

W 180  
D 46 - H 121,5 / 159,9

W 360  
D 46 - H 121,5 / 159,9

W 180  
D 46 - H 121,5 / 159,9

integrabile con  
contenitori Use  
Me / can be  
integrated with  
Use Me cabinets

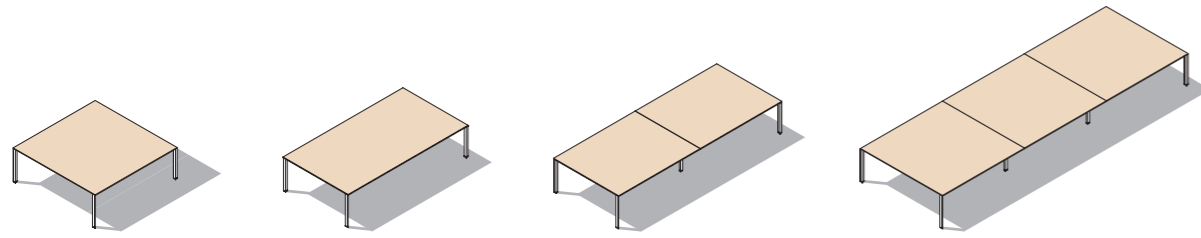

Meeting

W 120 / 165  
D 120 / 165 - H 74

W 220  
D 120 - H 74

W 320 / 330  
D 120 / 165 - H 74

W 440 / 495 / 600  
D 120 / 165 - H 74

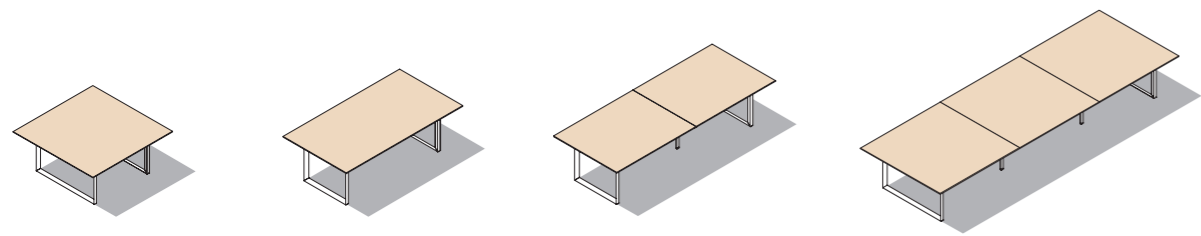

W 165  
D 165 - H 74

W 220  
D 120 - H 74

W 320 / 330  
D 120 / 165 - H 74

W 440 / 495 / 600  
D 120 / 165 - H 74

# Frame Collection

Sinetica

IT · Frame colpisce per l'aspetto minimalista, le linee essenziali e la particolare adattabilità del design. Costituito da una superficie in legno, melaminico o vetro, il piano da lavoro poggia su una struttura metallica che comprende gambe e profili perimetrali in alluminio trafilato.

EN · Frame strikes visitors with its minimalist appearance, its simple lines as well as its adaptable design. The wood, melamine or glass work top lays on a metal structure which includes drawn aluminium legs and edge trims.

FR · Frame marque par son aspect minimaliste, ses lignes et l'adaptabilité particulière de son design. Composé d'une surface en bois, mélamine ou verre, le plan de travail repose sur une structure métallique comprenant des piètements et des profils en aluminium extrudé.

DE · Frame besticht durch sein minimalistisches Erscheinungsbild, seine schlichte Linienführung und sein anpassungsfähiges Design. Die Arbeitsplatte aus Holz, Melamin oder Glas liegt auf einer Metallstruktur mit gezogenen Aluminiumbeinen und Randleisten.

ES · En Frame destacan su aspecto minimalista, las líneas simples y la particular adaptabilidad del diseño. Compuesto por una superficie de madera, melamina o cristal, la zona de trabajo se apoya sobre una estructura metálica compuesta por patas y perfiles de aluminio extruido.

RU · Рамка впечатляет своим минималистским внешним видом, исключительными линиями и особой технологичностью дизайна. Рабочая поверхность из дерева, меламин или стекла опирается на металлическую конструкцию, которая включает в себя ножки и профили по периметру из тянутого алюминия.



TYPE: Desk (h. 74 cm)

## Frame Collection

IT · Divisori rivestiti in tessuto, cassettiere su ruote, sedute ergonomiche e altri accessori contribuiscono a completare e personalizzare Frame in configurazione operativa, con essenziale struttura metallica bianca e pratico top in melaminico.

EN · Dividers upholstered in fabric, drawers on castors, ergonomic seats and several other accessories customize the operative configuration of Frame, completed by its characteristic essential white metal structure and its functional melamine top.

FR · Panneaux écrans revêtus en tissu, caissons sur roulettes, sièges ergonomiques et autres accessoires contribuent à compléter et personnaliser la gamme Frame en espace opératif, avec une essentielle structure métallique en finition blanc avec plateaux mélaminés.

DE · Mit Stoff bezogene Raumteiler, Schubladen auf Rollen, ergonomische Sitze und verschiedene andere Zubehörteile passen die operative Konfiguration von Frame an. Abgerundet wird dies durch die charakteristische Struktur aus weißem Metall und die funktionale Melamin-Platte.

ES · Separadores revestidos en tela, cajoneras con ruedas y asientos ergonómicos son algunos de los accesorios que completan y personalizan la gama Frame, con una estructura base metálica blanca y una práctica superficie en melamina.

RU · Покрытые тканью перегородки, выдвижные ящики на колесах, эргономичные сиденья и другие аксессуары вносят свой вклад в комплектацию и персонализацию Frame в рабочей конфигурации с необходимой структурой из белого металла и практичным меламиновым верхом.

TYPE: Bench (h. 74 cm)



## Frame Collection

IT · Frame, nella versione alta, diventa il protagonista di uno spazio conviviale, improntato a una calda e coinvolgente atmosfera. La struttura metallica con piano in rovere, crea un ideale abbinamento con le lampade, la libreria e gli sgabelli della collezione Sinetica.

EN · In its highest version, eventually surrounded by a warm and engaging atmosphere, Frame becomes the protagonist of the convivial space. The metal structure with oak top easily matches with Sinetica lamps, bookcases and stools.

FR · Frame, en version haute, devient le protagoniste d'un espace convivial, dans une atmosphère chaleureuse et accueillante. La structure métallique avec le plateau en chêne, s'assortit de façon optimale avec les lampes, la bibliothèque et les tabourets de la collection Sinetica.

DE · In seiner höchsten Version, die schließlich von einer warmen und einnehmenden Atmosphäre umgeben ist, wird Frame zum Protagonisten des geselligen Raums. Die Metallstruktur mit Eichenholzplatte passt gut zu Sinetica-Lampen, Bücherregalen und Hockern.

ES · Frame en versión alta es perfecto para ambientes sociales y transforma el espacio en una atmósfera cálida y envolvente. La estructura metálica con superficie en roble es ideal con la lámpara, la librería y los taburetes de la colección Sinetica.

RU · Frame, в высоком исполнении, становится главным героем праздничного пространства, отличающегося теплой и уютной атмосферой. Металлическая структура с дубовой поверхностью идеально сочетается с лампами, книжным шкафом и табуретами коллекции Sinetica.

TYPE: Convivial (h. 110 cm)





- 1 IT Flap in finitura piano
- EN Flap with same finish as the desk top
- FR FLAP en teinte avec le plateau
- DE Flap mit gleichen Tisch-Farbe
- ES Tapa con mismo acabado del escritorio
- RU Заглушка в цвет стола



- 2 IT Canala sganciabile per bench
- EN Removable cable tray for benches
- FR Bac amovible pour bench
- DE Abnehmbare Kabelwanne für doppelte Arbeitsplätze
- ES Bandeja desmontable para bench
- RU Съемный канал для скамейки



- 3 IT Cassetto sospeso con serratura
- EN Suspended drawer with lock
- FR Tiroir suspendu avec serrure
- DE Angehängte Schublade mit Schloss
- ES Cajon suspendido con cerradura
- RU Подвесной ящик с замком

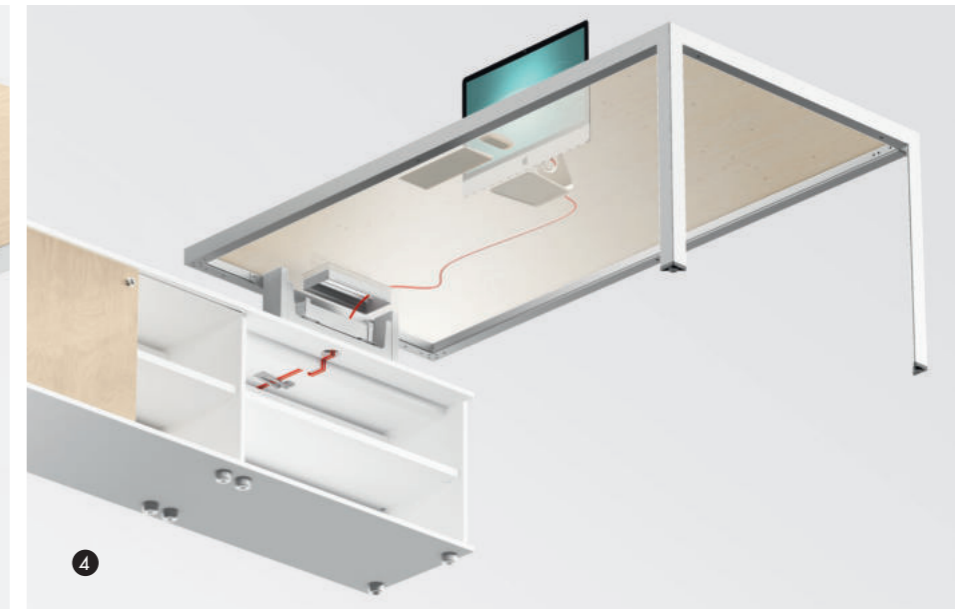

- 4 IT Cablaggio
- EN Wiring
- FR Câblage
- DE Verkabelung
- ES Cablaje
- RU Проводка



Prodotto brevettato  
Patented product

**100%  
GREEN**

Materiali sostenibili  
Sustainable materials

Frame Collection

Overview

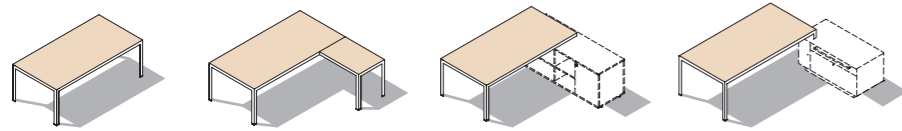

Desk

W 160 / 180 / 200 D 80 - H 74    W 160 / 180 / 200 D 160 - H 74    W 320 / 360 / 400 D 80 - H 74    W 480 / 540 / 600 D 80 - H 74

integrabile con contenitori Use Me / can be integrated with Use Me cabinets

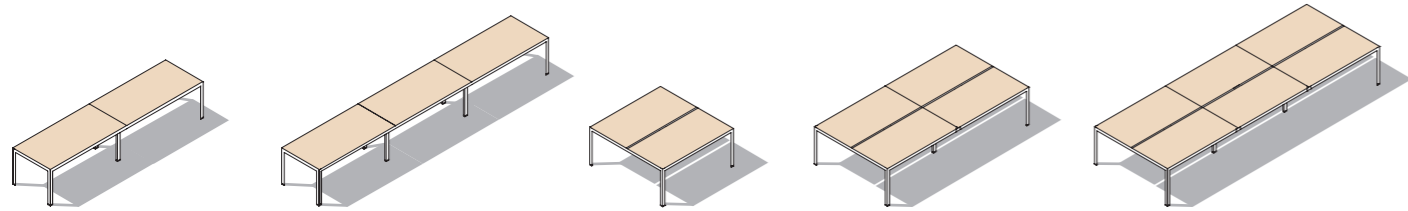

Bench

W 320 / 360 / 400 D 80 - H 74    W 480 / 540 / 600 D 80 - H 74    W 160 / 180 / 200 D 165 - H 74    W 320 / 360 / 400 D 165 - H 74    W 480 / 540 / 600 D 165 - H 74

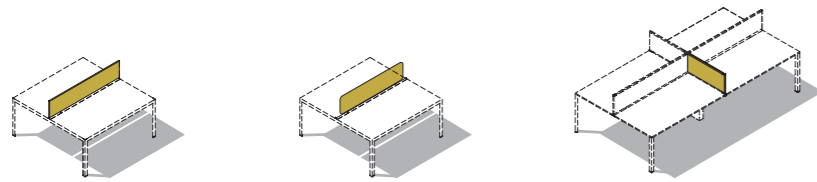

Screen

W 140 / 160 / 180 / 200 D 1,8 H 31,1 / 32,9 / 35,3 / 37,1    W 140 / 160 / 180 / 200 D 1,8 H 36    W 80 D 1,8 H 32,9 / 37,1

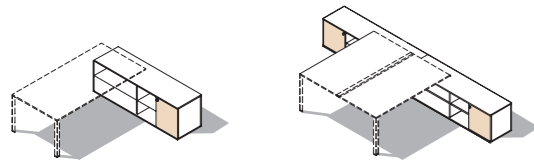

Hub

W 180 D 46 - H 54,5    W 360 D 46 - H 54,5

integrabile con contenitori Use Me / can be integrated with Use Me cabinets

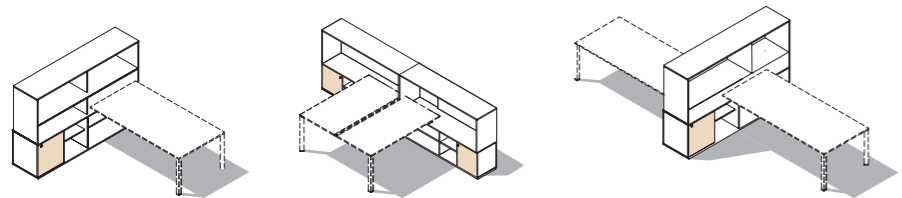

W 180 D 46 - H 121,5 / 159,9    W 360 D 46 - H 121,5 / 159,9    W 180 D 46 - H 121,5 / 159,9

integrabile con contenitori Use Me / can be integrated with Use Me cabinets

Frame Collection

Overview

Sinetica

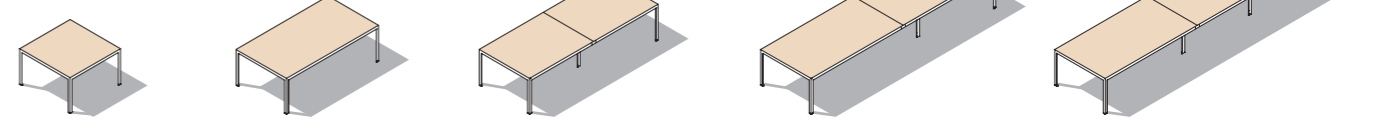

Meeting

W 120 / 165 D 120 / 165 - H 74    W 220 D 120 - H 74    W 320 / 330 D 120 / 165 - H 74    W 440 D 120 - H 74    W 600 / 495 D 120 / 165 - H 74

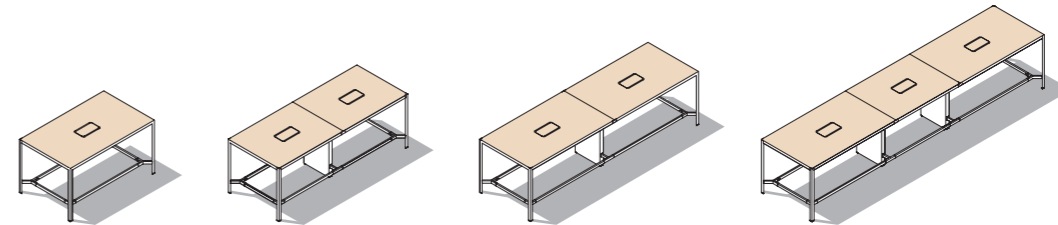

Convivial

W 220 D 120 - H 110    W 320 D 120 - H 110    W 400 D 120 - H 110    W 600 D 120 - H 110



IT · Una scrivania componibile che coniuga la concretezza del legno alla raffinatezza del tessuto e che sfrutta il sapiente uso dei materiali come punto di forza e originalità. Lampade, cassettiere, divisori e librerie della collezione Use Me, possono essere abbinati in maniera armonica per creare un ambiente lavorativo dinamico e flessibile.

EN · A modular workstation that combines the concreteness of the wood with the prestige of the fabric, and that takes the smart usage of the materials as a point of strength and originality. In order to create a dynamic but versatile working environment, Use Me lamps, drawers, screens, and bookcases can be matched to the workstation with an harmonious result.

FR · Un bureau modulaire qui allie la force du bois au raffinement du tissu, alliance des matériaux comme point de force et d'originalité. Lampes, caissons et rangements de la collection Use Me se marient harmoniquement pour créer un milieu de travail dynamique et flexible.

DE · Ein modulare Schreibtisch, die die Konkretheit des Holzes mit dem Prestige des Stoffes verbindet und die intelligente Verwendung der Materialien betrachtet. Lampen, Kommode, Trennwände und Büchregal aus der Use Me-Kollektion lassen sich harmonisch zu einer dynamischen und flexiblen Arbeitsumgebung kombinieren.

ES · Un escritorio modular que une la fuerza de la madera y el refinamiento del tejido, una conexión entre firmeza y originalidad. Lámparas, cajoneras, separadores y librerías de la colección Use Me se pueden combinar de manera armónica para crear un ambiente de trabajo dinámico y flexible.

RU · Сборный стол, который сочетает в себе конкретность дерева с изысканностью ткани и мудро использует материалы как в их прочности. Лампы, кассетницы, разделители и книжные шкафы из коллекции Use Me могут сочетаться в создании динамичной рабочей среды.



## Stay Collection

IT · Linee arrotondate, finiture naturali e capacità di andare oltre gli schemi ed i ruoli tradizionali: questi sono i concetti chiave dei tavoli Stay, ideali per ambienti dinamici, condivisi e con richiami alle atmosfere domestiche.

EN · Round lines, natural finishes and the ability to get out from the schemes and the traditional roles with a domestic scent: these are the key concepts of the Stay tables, ideal items for dynamic environments and public areas.

FR · Lignes arrondies, finitions naturelles et capacité à dépasser les schémas et les rôles traditionnels : tels sont les concepts clés des tables Stay, idéaux pour des espaces dynamiques et partagés, comme à la maison.

DE · Runde Linien, natürliche Oberflächen und die Fähigkeit, mit heimischen Düften aus den Schemata und den traditionellen Rollen herauszukommen: Dies sind die Schlüsselkonzepte der Stehtische, die ideal für dynamische Umgebungen und öffentliche Bereiche geeignet sind.

ES · Líneas curvas, acabados naturales y capacidad de sobrepasar los esquemas y papeles tradicionales: esta es la base de las mesas Stay, ideales para ambientes dinámicos, sociales y para espacios en el hogar.

RU · Закругленные линии, естественная отделка и возможность выйти за рамки традиционных моделей и ролей: это ключевые концепции столов Stay, идеально подходящих для динамичных общих сред с акцентами на домашнюю атмосферу.

TYPE: Hub (h. 74 cm)



TYPE: Bench (h. 74 cm)



IT · In versione bench, mantiene la leggerezza formale e le finiture naturali che caratterizzano l'intera famiglia, creando situazioni d'arredo che favoriscono l'aggregazione tra le persone e l'interazione con le tecnologie.

EN · Stay benches keep the collection's formal lightness and the natural finishes, creating environments that promote the interaction with both people and technology.

FR · Les tables Stay en version bench gardent la légèreté des formes et des finitions naturelles qui caractérisent la gamme, créant des espaces qui favorisent cohésion et interaction avec les technologies.

DE · Stehbänke behalten die formale Leichtigkeit und die natürlichen Oberflächen der Kollektion und schaffen Umgebungen, in denen die Interaktion mit Menschen und Technologie gefördert wird.

ES · Las mesas Stay en versión banco mantienen las líneas sutiles y los acabados naturales que caracterizan a la gama, y crean espacios que favorecen la interacción de las personas con la tecnología.

RU · Столы Stay версий Bench поддерживают формальную легкость и естественную отделку, которые характеризуют полную семью, создавая обстановку, способствующую объединению людей и взаимодействию с технологиями.

## Stay Collection

IT · Dall'integrazione fra i tavoli Stay ed un completo abaco di contenitori e accessori, nascono molteplici soluzioni che uniscono più funzionalità: dall'operatività, al contenimento, alle situazioni dedicate ai colloqui ed alla convivialità.

EN · The combination between the Stay meeting tables and the complete selection of containers and accessories gives origin to several solutions fulfilling a variety of functions: operability, containment, creation of environments for meetings.

FR · L'intégration au programme Stay d'une gamme complète de rangements et d'accessoires a conduit à la création de multiples solutions qui combinent plusieurs fonctions: opératives, de classement, collectives et conviviales.

DE · Die Kombination zwischen den Stay Tisch und der kompletten Auswahl an Einzelmöbel und Zubehör führt zu verschiedenen Lösungen, die eine Vielzahl von Funktionen erfüllen: Bedienbarkeit, Eindämmung, Erstellen von Umgebungen für Besprechungen.

ES · La combinación de las mesas Stay con una gama completa de cajas de almacenaje y accesorios crean una multitud de soluciones con numerosos usos: funcionalidad, almacenamiento y favorecimiento de ambientes sociales.

RU · Из интеграции столов Stay и полным набором контейнеров и аксессуаров рождается масса решений, которые сочетают в себе множество функций: от оперативности до локализации и до ситуаций, посвященных собеседованиям и веселью.

TYPE: Team storage (h. 74 / 159,9 cm)



TYPE: Meeting (h. 74 cm)



IT - La particolare forma dei tavoli Stay, pensati per riunioni o altre situazioni collettive, facilita la fruizione dei contenuti multimediali sullo schermo a parete, mantenendo allo stesso tempo tutti i partecipanti in relazione reciproca.

EN - The unique shape of the Stay desks, designed for meetings and collective situations, facilitates the use of multimedia contents on the wall screen, while keeping all of the participants in a reciprocal relation.

FR - La forme particulière des tables Stay, conçue pour les réunions ou autres rassemblements, facilite l'utilisation mural des outils multimédia et l'échange entre les participants.

DE - Die einzigartige Form der Aufenthaltstische, die für Meetings und kollektive Situationen konzipiert wurde, erleichtert die Verwendung von Multimediainhalten auf dem Wandbildschirm und hält alle Teilnehmer in einer wechselseitigen Beziehung.

ES - La forma particular de las mesas Stay han sido pensadas para reuniones y otras actividades sociales, por lo que posibilita el uso de contenidos multimedia en una pantalla en la pared y facilita la interacción de los participantes.

RU - Особая форма столов Stay, предназначенных для встреч или других коллективных ситуаций, облегчает использование мультимедийного содержимого на настенном экране, таким образом, что все участники при этом остаются в коммуникации друг с другом.

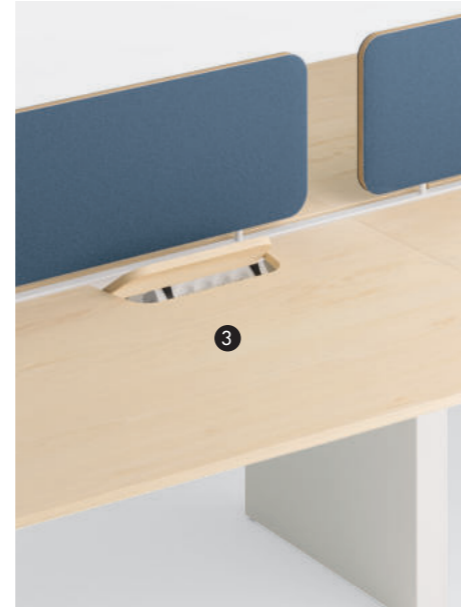
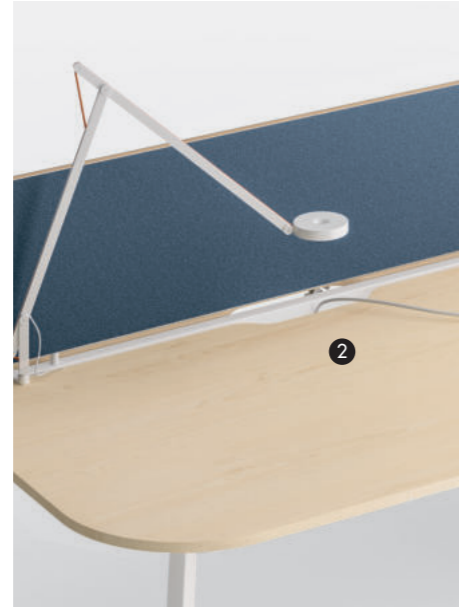

1 IT *Kit staffe porta prese*  
 EN *Brackets kit to carry electrical socket*  
 FR *Fixations support prises au-dessus du plateau pour bench*  
 DE *Obere Steckdose-kit*  
 ES *Caja eléctrica superior*  
 RU *Комплект подразетников*

2 IT *Asola passacavi*  
 EN *Central scallop*  
 FR *Défonçage centrale sur le plateau*  
 DE *Mittig Kabel-Loch*  
 ES *Ojal pasacable central*  
 RU *Центральная прорезь для кабеля*

3 IT *Flap in finitura piano*  
 EN *Flap with same finish as the desk top*  
 FR *FLAP en teinte avec le plateau*  
 DE *Flap mit gleichen Tisch-Farbe*  
 ES *Tapa con mismo acabado del escritorio*  
 RU *Флар на отделке поверхности*



4 IT *Top access*  
 EN *Top access*  
 FR *Top accès*  
 DE *Klappe*  
 ES *Tapa registrable*  
 RU *Заглушка в цвет стола*



6 IT *Cablaggio*  
 EN *Wiring*  
 FR *Câblage*  
 DE *Verkabelung*  
 ES *Cablaje*  
 RU *Проводка*

Stay Collection

Overview

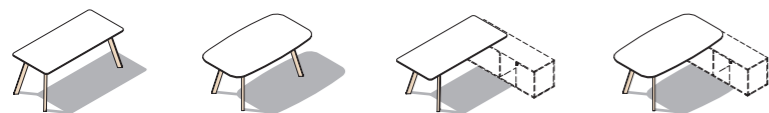

Desk

W 160 / 180 / 200  
D 80 / 100 - H 74

W 180 / 200  
D 100 - H 74

integrabile con  
contenitori Use  
Me / can be  
integrated with  
Use Me cabinets

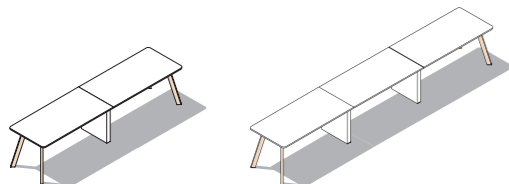

Bench

W 320 / 360  
D 80 - H 74

W 480 / 540  
D 80 - H 74

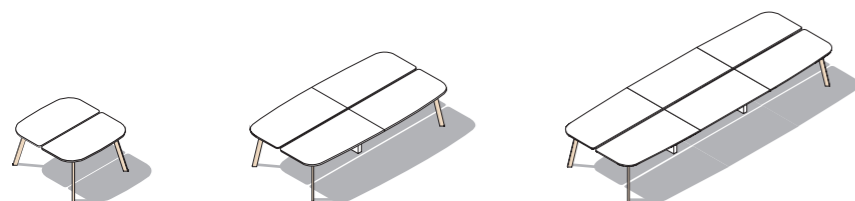

W 160 / 180  
D 165 - H 74

W 320 / 360  
D 165 - H 74

W 480 / 540  
D 165 - H 74

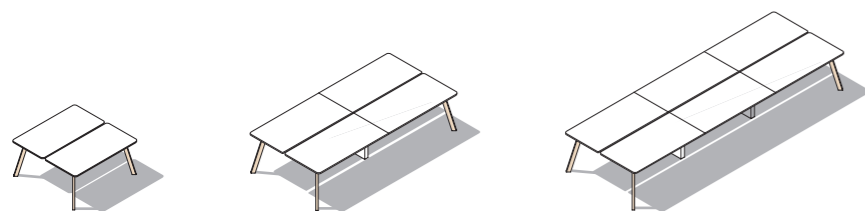

W 160 / 180  
D 165 - H 74

W 320 / 360  
D 165 - H 74

W 480 / 540  
D 165 - H 74



Screen

W 140 / 160  
D 1.8 / 3 - H 68,5

W 140 / 160  
D 1.8 / 3 - H 36

Stay Collection

Overview

Sinetica

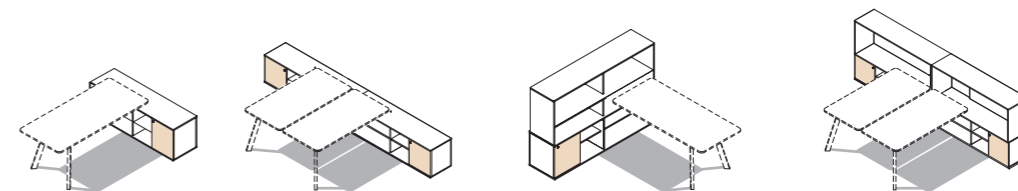

Hub

W 180  
D 46 - H 54,5

W 360  
D 46 - H 54,5

W 180  
D 46 - H 121,5 / 159,9

W 360  
D 46 - H 121,5 / 159,9

integrabile con  
contenitori Use  
Me / can be  
integrated with  
Use Me cabinets



Meeting

Ø 120  
H 74

W 165  
D 165 - H 74

W 165  
D 165 - H 74

W 240  
D 120 - H 74

W 180 / 240 / 280  
D 100 / 120 - H 74

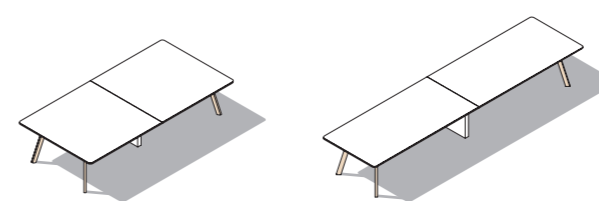

W 332  
D 165 - H 74

W 480  
D 120 - H 74

IT · We Meet costituisce un innovativo progetto destinato a trovare spazio negli ambienti ufficio attuali.

La modularità e la struttura free standing dei vari elementi, consentono di dare vita facilmente ad un'infinità di soluzioni, caratterizzate dal calore del legno, dal fascino del tessuto e da una gradevole sensazione di comfort acustico.

EN · We Meet is an innovative project to be placed in the most contemporary working environments. Its modularity, together with the free standing structure of the different elements, allows to design a great variety of solutions, always characterized by the warmth of the wood, the charm of the fabric and the pleasant feeling of the acoustic comfort.

FR · We Meet est un projet novateur conçu pour créer de l'espace dans les bureaux d'aujourd'hui. La modularité et la structure autoportante des différents éléments permettent de créer facilement un nombre infini de solutions. We Meet marie la chaleur du bois, le charme du tissu et l'agréable sensation de confort acoustique.

DE · We Meet ist ein innovatives Projekt, das in den modernsten Arbeitsumgebungen platziert wird. Seine Modularität und seine Struktur ermöglicht die Gestaltung einer Vielzahl von Lösungen, die sich stets durch die Wärme des Holzes, den Charme des Gewebes und das angenehme Gefühl des akustischen Komforts auszeichnen.

ES · We Meet es un innovador proyecto para espacios de trabajo modernos. El sistema modular y la estructura autoportante de sus diversos elementos dan vida a una infinidad de soluciones, caracterizadas por el calor de la madera, la sutileza de los tejidos y la agradable sensación del confort acústico.

RU · We Meet - это инновационный проект, предназначенный для поиска места в современной офисной среде. Модульность и структура различных элементов позволяют легко создавать бесконечное количество решений, характеризующихся теплотой дерева, очарованием ткани и приятным ощущением акустического комфорта.



TYPE: Cubicle (h. 140 cm)



TYPE: Sofa (h. 140 cm)



IT · La possibilità di affiancare più moduli permette di creare composizioni nelle quali privacy, convivialità e operatività convivono. La combinazione di elementi consente di gestire lo spazio e permette la creazione di postazioni individuali e luoghi d'incontro.

EN · The possibility to juxtapose the modules allows the creation of compositions, where privacy, conviviality and operability live together. The combination of elements allows to organize the space and to create individual workstations and meeting places.

FR · La possibilité d'assembler plusieurs modules permet de créer des compositions dans lesquelles intimité, convivialité et concentration coexistent. La combinaison d'éléments permet d'organiser l'espace de manière flexible et de créer des postes individuels ou de lieux de rencontre.

DE · Die Möglichkeit, die Module nebeneinander zu stellen, ermöglicht die Erstellung offener Kompositionen. Durch die Kombination von Elementen können Sie den Raum organisieren sowie individuelle Arbeitsplätze mit unterschiedlichen Höhen und Treffpunkten erstellen.

ES · La posibilidad de conectar más módulos permite crear elegantes composiciones. Convivencia y funcionalidad coexisten con armonía. La unión entre decoración, mobiliario y paneles divisorios crea áreas de trabajo individuales con diferentes alturas.

RU · Возможность объединения нескольких модулей позволяет создавать открытые и пластичные композиции, в которых сочетаются удобство и функциональность. Комбинация мебели и перегородок позволяет аккуратно управлять пространством.

## We Meet Collection

IT · La multimedialità può diventare parte integrante di qualsiasi ambiente, dalle sale meeting agli ambienti didattici, ricreativi e lounge, sempre all'insegna della leggerezza formale e del dinamismo. I pannelli divisorii propongono una struttura freestanding, presentano una elevata insonorizzazione e sono abbinabili a tavoli riunione, divani e media lounge.

EN · Multimedia can become an integral part of any environment, from the meeting halls and lounge areas, to the educational and recreational environments, always maintaining a formal lightness and dynamism. The dividing panels, combinable with meeting tables, sofas and video screen, offer a freestanding structure and have an high soundproofing.

FR · Le multimédia peut faire partie intégrante de tout environnement, des salles de réunion aux environnements éducatifs, récréatifs et lounge, toujours avec légèreté et dynamisme. Les panneaux de séparation autoportants présentent une insonorisation efficace et peuvent être combinés avec des tables de réunion, des canapés et des supports vidéo.

DE · Multimedia kann ein fester Bestandteil jeder Umgebung werden. Die mit Besprechungstischen, Sofas und Bildschirm kombinierbaren Trennwände bieten eine freistehende Struktur und eine hohe Schallisolierung.

ES · La tecnología está presente en cualquier lugar: salas de reuniones, espacios didácticos, áreas de ocio o bares. Los paneles divisorios son autoportantes, tienen gran insonorización y se pueden combinar con mesas, sofás y módulos para vídeo.

RU · Мультимедийность может стать неотъемлемой частью любой среды, от залов заседаний до образовательных, развлекательных и гостиных. Разделительные панели имеют автономную конструкцию, обладают высокой звукоизоляцией и могут сочетаться со столами для совещаний, небольшими диванами, модулями для техники.

TYPE: Media lounge (h. 172 cm)



TYPE: Touch down (h. 140 cm)



1 IT Cablaggio spot Schuko e USB + RJ45  
 EN Wiring  
 FR Câblage  
 DE Verkabelung  
 ES Cblaje  
 RU Проводка



2 IT Asola passacavi centrale  
 EN Central scallop  
 FR Défonçage centrale sur le plateau  
 DE Mittig Kabel-Loch  
 ES Ojal pasacable central  
 RU Центральная прорезь для кабеля



3 IT Gestione del cablaggio  
 EN Wiring system  
 FR Système de câblage  
 DE Verkabelung  
 ES Sistema de cblaje  
 RU Управление каблированием



4 IT Kit staffe porta prese  
 EN Brackets kit to carry electrical socket  
 FR Fixations support prises au-dessus du plateau pour bench  
 DE Obere Steckdose-kit  
 ES Caja eléctrica superior  
 RU Комплект подразетников



5 IT Sistema di aggancio rivestimento  
 EN Upholstery hooking system  
 FR Fixation panneaux revetu  
 DE Hakensystem für Beschichtung  
 ES Sistema de enganche  
 RU Система крепления обшивки

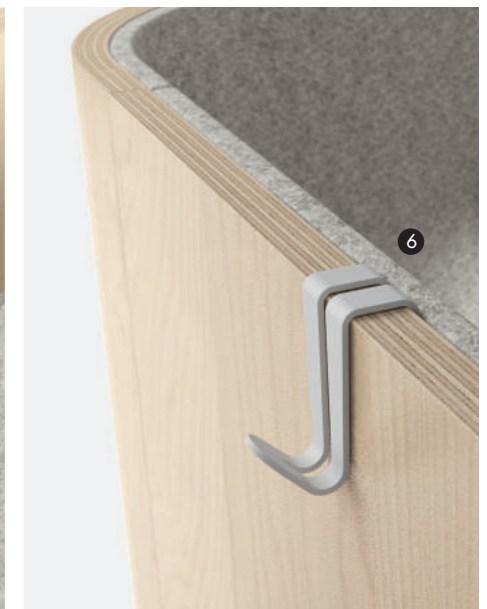

6 IT Appendiabiti  
 EN Coat hanger  
 FR Support vêtements  
 DE Kleiderbügel  
 ES Perchero  
 RU Вешалка

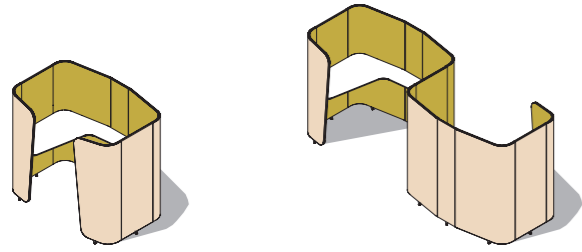

Cubicle

W 151  
D 109 – H 140

W 300  
D 110 – H 140

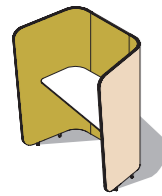

Touch down

W 113  
D 68 – H 140  
Desk H 74

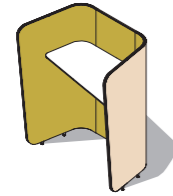

W 113  
D 68 – H 140  
Desk H 105

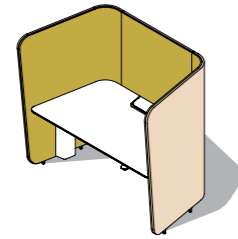

Focus

W 156  
D 93 – H 140  
Desk H 65 / 105

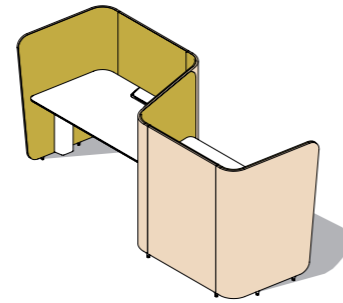

W 296  
D 107 – H 140  
Desk H 74

regolabile  
in altezza /  
height  
adjustable

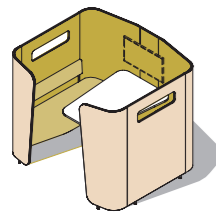

Chat sofa

W 190  
D 159 – H 140

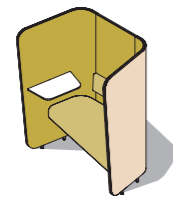

Phone point

W 113  
D 68 – H 140

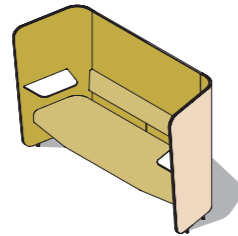

Sofa

W 191  
D 68 – H 140

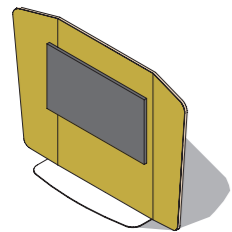

Media lounge

W 300  
D 63 – H 172

# Vogue Collection

Sinetica

IT · Caratterizzato dal brillante telaio metallico a vista, abbinato al calore del legno e della pelle, Vogue crea uno scenario in armonia fra tradizione e innovazione, con una venatura di irresistibile prestigio. Trasmette un senso di eleganza e fascino, senza rinunciare ad una linearità tipicamente contemporanea nelle forme e nei volumi.

EN · Characterised by the visible shining metal frame, and paired to the warmth of the veneer and of the leather, Vogue creates a scenario of both tradition and innovation, with a vein of irresistible prestige. The collection conveys a sense of elegance and charm, without giving up to a typical contemporary linearity in its shapes and volumes.

FR · Avec son profil métallique brillant associé à la chaleur des matériaux comme le bois et le cuir, le bureau Vogue à l'apparence distinguée, crée un scénario harmonieux entre tradition et innovation. Il dégage élégance et charme sans renoncer aux formes et aux volumes linéaires contemporains.

DE · Vogue zeichnet sich durch den sichtbaren, glänzenden Metallrahmen aus und passt sich der Wärme des Furniers und des Leders an. Er schafft ein Szenario aus Tradition und Innovation mit einem unwiderstehlichen Prestige. Die Kollektion vermittelt ein Gefühl von Eleganz und Charme.

ES · Caracterizado por una brillante estructura en metal y conectado con el calor de la madera y la piel, Vogue crea un ambiente de armonía entre la tradición y la innovación. Transmite elegancia y fascinación sin renunciar a líneas contemporáneas.

RU · Выполненный с использованием блестящего металлического профиля в слиянии с природной теплотой натурального дерева и кожи, стол Vogue является героем этого сценария: в гармонии с традициями и инновационным подходом, строгостью линий и выдержанным сочетанием натуральных материалов.



IT · Con il suo aspetto autorevole e il suo innovativo profilo a T, Vogue costituisce l'elemento centrale di ambienti executive e manageriali. La robusta struttura accoglie superfici in legno, melaminico, laccato e pelle e diventa finalmente versatile e pronta ad affrontare ogni sfida.

EN · With its authoritative appearance and its innovative T-shape, Vogue is the key element of executive environments. Its strong structure includes veneer, melamine, lacquered and leather surfaces, making the item versatile and ready to face every kind of challenge.

FR · Avec sa ligne prononcée et son profil innovant en T, le bureau Vogue constitue l'élément central d'environnements directionnels. La structure robuste supporte des surfaces en bois, mélamine, laque et cuir pour une utilisation polyvalente et prête à relever tous les défis.

DE · Mit dem renommierten Look und das innovative T-Profil ist Vogue das Hauptelement in den Räumen der Geschäftsleitung. Die starke, vielseitig verwendbare Struktur trägt Holz-, Leder-, lackierte und melaminbeschichtete Oberflächen und nimmt jede Herausforderung an.

ES · Con su innovador perfil en T, Vogue constituye el elemento central de los ambientes ejecutivos. La sólida estructura acoge superficies de madera, piel, melamina o lacadas y se convierte en un elemento versátil capaz de afrontar cualquier desafío.

RU · Благодаря своему внушительному внешнему виду и инновационному T-образному профилю, является главным элементом исполнительной и управленческой среды. Прочная структура объединяет в себе поверхности из дерева, лака и кожи и становится готовой к любым испытаниям.

TYPE: Desk (h. 74 cm)



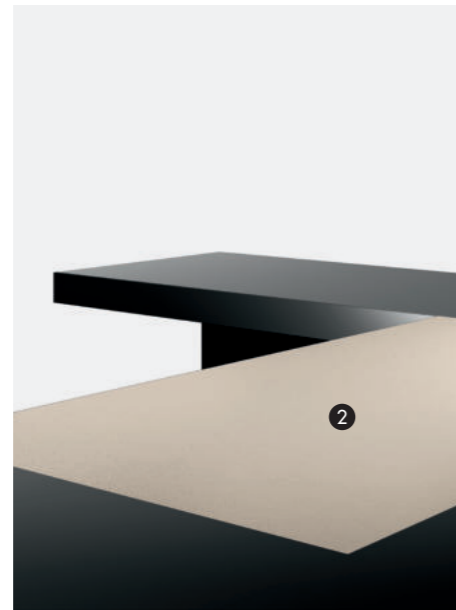

1	IT	Profilo in metallo
	EN	Metal structure
	FR	Profil en métal
	DE	Metal Gestell
	ES	Estructura en metal
	RU	Профиль из металла

2	IT	Piano con inserto in pelle
	EN	Leather top
	FR	Plateau avec partie en cuir
	DE	Platte aus Leder
	ES	Sobre en cuero
	RU	Поверхность с вставкой из кожи

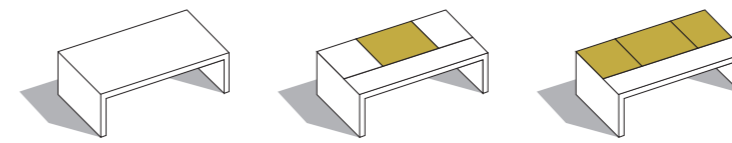

Desk  
W 240  
D 100 – H 74

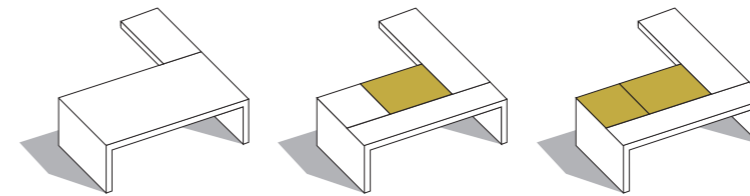

Desk with return  
W 240  
D 200 – H 74

IT · Trasmette un senso di eleganza e fascino senza rinunciare ad una linearità tipicamente contemporanea nelle forme e nei volumi. Il piano in legno e laccato presenta sottomani in pelle ed ecopelle, mentre la particolare disposizione del piano dattilo consente una elevata fruibilità.

EN · It conveys a sense of elegance and charm, without giving up the typical contemporary linearity of forms and volumes. The lacquered and veneer top comes with either a leather or eco-leather desk pad; on its side, the position of the return top allows an high level of usability.

FR · Il transmet élégance et charme sans renoncer à une linéarité contemporaine des formes et des volumes. Sous-mains en cuir ou synthétique intégré au plateau en bois et laque ; la position particulière du retour, également disponible en bois ou laque, permet une grande facilité d'utilisation.

DE · Es vermittelt Eleganz und Charme, ohne dabei die zeitliche Linearität aufzugeben. Die Platte ist mit einer Schreibtischunterlage aus Leder oder Kunstleder ausgestattet. Die Position des Rückenteils erlaubt auf seiner Seite ein hohes Maß an Benutzerfreundlichkeit.

ES · Transmite elegancia sin renunciar a las líneas contemporáneas. La superficie de madera y lacada cuenta con una almohadilla de piel o ecopiel, y la disposición del ala anexa, disponible en lacado o madera, ofrece una superficie más amplia para trabajar.

RU · Передача чувства элегантности и очарования, не отказываясь от современных линейных форм и объемов, - такова философия коллекции More, новинки от компании Sinetica, предназначенной для кабинета руководителя.





TYPE: Desk (h. 74 cm)



IT · Volumi e spessori importanti contraddistinguono la scrivania, vestita con raffinati abbinamenti di legni pregiati, superfici laccate e rivestimenti in pelle, realizzati con una qualità artigianale e dal taglio sartoriale.

EN · Important volumes and thickness are the key feature of this desk, whose finish is based on a refined match of precious woods, lacquered surfaces and leather coverings of handmade quality and tailored cuts.

FR · Des volumes et des épaisseurs importants caractérisent le bureau, habillé de finitions raffinées comme bois nobles, surfaces laquées et revêtements en cuir et réalisé avec un soin artisanal.

DE · Wichtige Volumen und Dicke sind das Hauptmerkmal dieses Schreibtisches, dessen Verarbeitung auf einem raffinierten Zusammenspiel von Edelhölzern, lackierten Oberflächen und Lederbezügen in handgearbeiteter Qualität und Sondermaße basiert.

ES · Volúmenes y grosos importantes caracterizan al escritorio, cuyo acabado se combina con maderas nobles, superficies lacadas y tapicerías de piel, todo con una calidad artesanal y líneas a medida.

RU · Значительные объемы и толщина характеризуют стол, покрытый изысканными сочетаниями ценных пород дерева, лакированными поверхностями и кожаной обивкой, выполненный в ремесленном качестве.

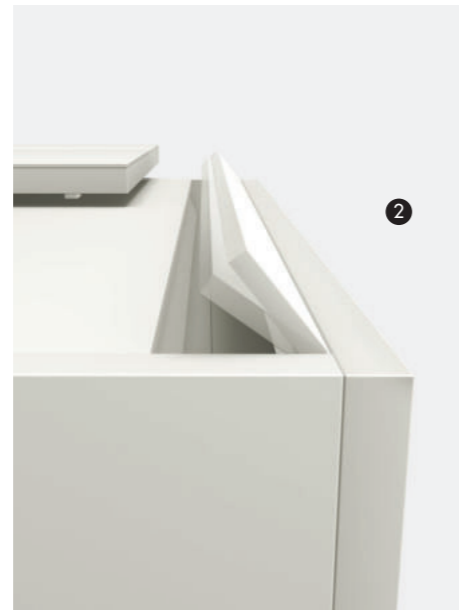

1 IT *Piano con inserto in pelle e top access*  
 EN *Top with a leather pad and top*  
 FR *Plateau avec insert en cuir*  
 DE *Platte mit Ledereinsatz und Klappe*  
 ES *Superficie con almohadilla en piel y tapa registrable*  
 RU *Бювар черная кожа и набор элементов*

2 IT *Top access*  
 EN *Top access*  
 FR *Top accès*  
 DE *Klappe*  
 ES *Tapa registrable*  
 RU *Заглушка по длине стола в цвет стола*

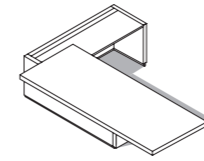

Desk  
 W 270  
 D 200 – H 74

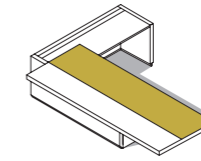
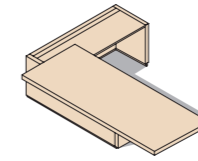

Desk with leather  
 W 270  
 D 200 – H 74

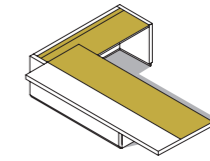

# Use Me Collection

Sinetica

IT · I complementi ideali per ampliare l'arredo di postazioni di lavoro, una collezione organica per l'organizzazione dello spazio che include armadietti, recycling point e mobili spina, ma anche arredi di servizio, cassettiere e armadi per l'archiviazione. Grazie alla collezione Use Me il lavoro di ogni giorno diventa più semplice, produttivo e smart.

EN · Use Me collection is the ideal complement to expand the furnishing of the workstations; with its cabinets, recycling point, plug units, service pieces of furniture, drawers and storage units, Use Me is a complete collection for the organisation of the space. Thanks to its several different elements, everyday work becomes easier, smarter and more productive.

FR · Pas seulement un système d'archivage, mais un outil d'organisation de l'espace et du travail qui comprend des meubles de rangement ou d'archivage, des caissons, recycling point et meubles partagés et connectés. Grâce à la collection Use Me, le travail journalier devient plus simple, productif et smart.

DE · Die Use Me Kollektion ist die ideale Ergänzung, um die Ausstattung der Arbeitsplätze zu erweitern. Use Me ist mit seinen Schränken, Recyclingstellen, Steckereinheiten, Servicemöbeln, Schubladen und Lagereinheiten eine vollständige Kollektion für die Raumorganisation. Die tägliche Arbeit wird durch verschiedene Elemente einfacher, intelligenter und produktiver.

ES · Son los complementos ideales a la hora de añadir mobiliario a la oficina. Es una colección que incluye aparadores, puntos de reciclaje, enchufes, casilleros y archivadores. Gracias a la colección Use Me, el trabajo de cada día se simplifica y llega a ser más productivo y eficaz.

RU · Идеально дополняет расширение меблировки рабочих мест, это органическая коллекция для организации пространства, которая включает в себя шкафчики, пункты переработки и мебель для штепселей, но и также служебную мебель, комоды и картотечные шкафы. Благодаря коллекции Use Me повседневная работа становится проще, продуктивнее и быстрее.



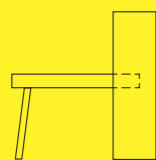

Integrabile con collezioni Diamond Evo, Frame Evo e Stay / Can be integrated with Diamond Evo, Frame Evo and Stay collections

IT · Use Me risolve diverse esigenze di archiviazione con un unico sistema modulare, interpretando la serialità come un fattore di innovazione e trasformazione. La compatibilità con gli altri prodotti, lo rende uno strumento d'arredo trasversale, capace di unire la funzione di contenimento con quella di progettazione e gestione dello spazio.

EN · With its modular system, the Use Me collection meets every storage need, transforming sequences into innovation. The adaptability of the Use Me collection to all of the other Sinetica items makes it an interesting furnishing tool, which fulfils both the function of a container and the function of the organization and design of the space.

FR · Use Me résout les besoins de classement avec un système modulaire unique, interprétant la sérialité comme un facteur d'innovation et transformation. La compatibilité avec les autres gammes en fait un outil d'aménagement capable de répondre aux exigences de classement, ameublement et gestion de l'espace.

DE · Mit dem modularen System erfüllt die Kollektion Use Me alle Archivierungsanforderungen. Die Anpassungsfähigkeit dieser Kollektion an alle anderen Artikel macht sie zu einem interessanten Einrichtungselement, das sowohl die Funktion eines Behälters als auch der Planung und Gestaltung des Raumes erfüllt.

ES · Use Me propone varias soluciones de almacenaje con un sistema modular innovador y transformador. Su afinidad con los otros productos hace que esta colección sea interesante y capaz de hacer frente a las exigencias de almacenaje y gestión del espacio.

RU · Use Me решает различные задачи хранения с помощью единой системы, интерпретируя последовательность как фактор преобразований. Совместимость с другими изделиями делает его инструментом для мебелировки, способным сочетать функции размещения с функциями проектирования пространством.

## Use Me Collection

IT · I contenitori Use Me possono diventare il punto focale di una postazione individuale, replicabile in serie o personalizzabile in molteplici varianti, per creare i più diversi scenari operativi.

EN · The Use Me containers are able to become the key point of an individual workstation, which can be repeated in a series or customised in different varieties, with the result of creating different operative scenarios.

FR · Les rangements Use Me peuvent devenir le point central d'un poste individuel, répliquable en série ou personnalisable pour créer les scénarios de fonctionnement les plus divers.

DE · Die Use-Me-Container können zum Schlüsselpunkt einer einzelnen Workstation werden, die in einer Reihe wiederholt oder in verschiedenen Varianten angepasst werden kann, wodurch verschiedene operative Szenarien erstellt werden.

ES · Los espacios de almacenamiento de Use Me pueden convertirse en elemento clave del área de trabajo, pues se puede personalizar con múltiples soluciones, pudiendo crear de esta manera una multitud de espacios posibles.

RU · Контейнеры Use Me могут стать фокусной точкой личного пространства, с серийными репликами или индивидуально, в многочисленных вариантах, для создания самых разнообразных рабочих сценариев.

TYPE: Hub (h. 74 / 159,9 cm)



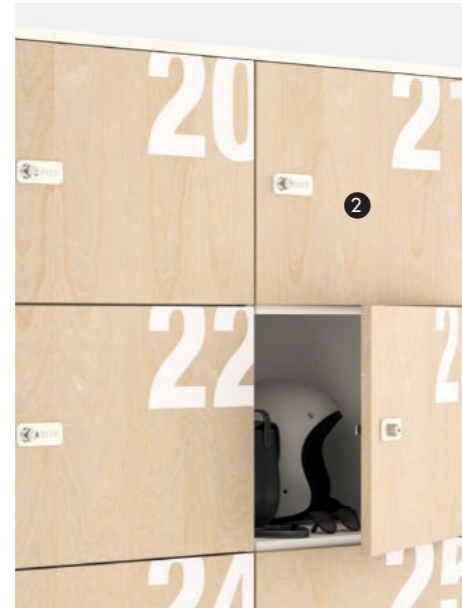

1 IT *Cassetto sospeso interno*  
 EN *Suspended internal drawer*  
 FR *Tiroir suspendu interne*  
 DE *Innere hängende Schublade*  
 ES *Cajón suspendido interna*  
 RU *Внутренний подвесной ящик*

2 IT *Armadietti personali*  
 EN *Personal lockers*  
 FR *Armoires personnelles*  
 DE *Schließfächer*  
 ES *Armarios personales*  
 RU *Индивидуальные шкафчики*



3 *Recycling point*

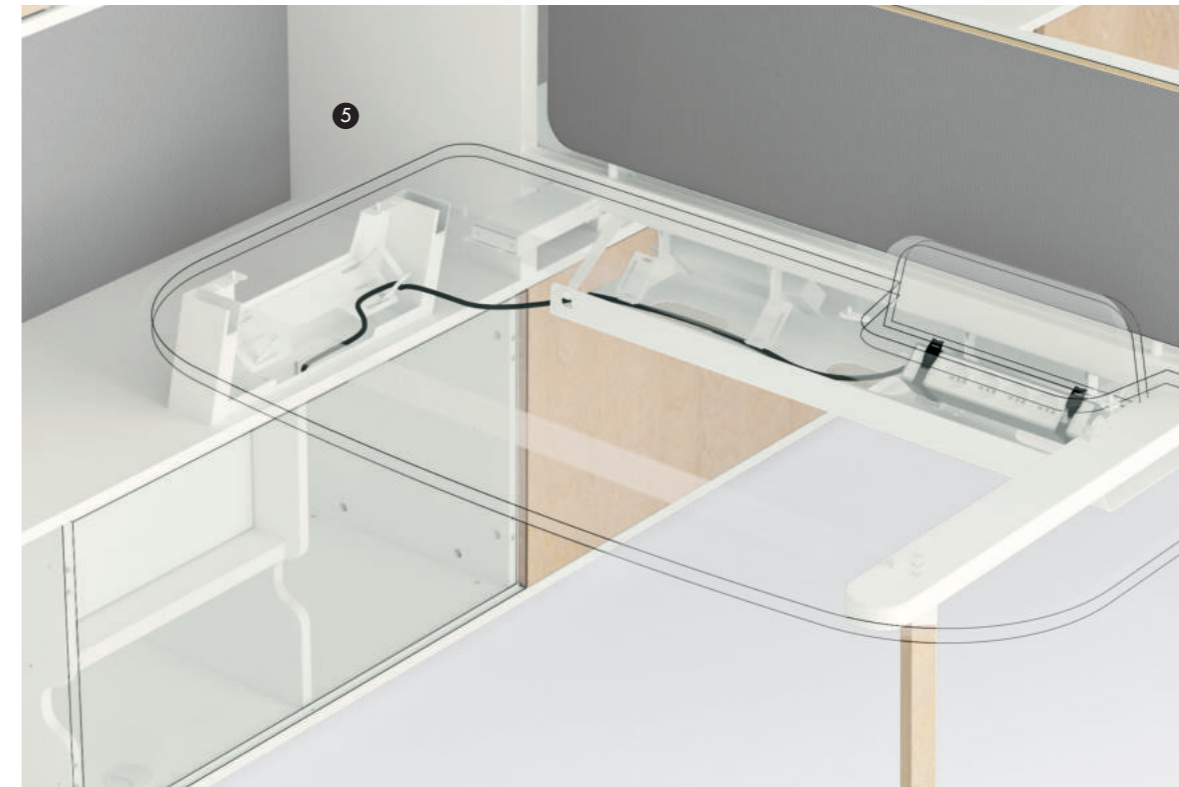

5 IT *Cablaggio*  
 EN *Wiring*  
 FR *Câblage*  
 DE *Verkabelung*  
 ES *Cablaje*  
 RU *Проводка*

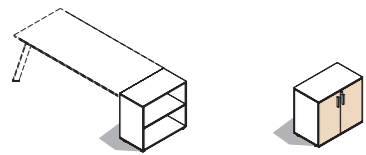

Side cabinet

W 80  
D 46 – H 74

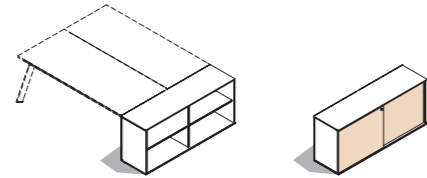

W 165  
D 46 – H 74

integrabile con  
contenitori Use  
Me / can be  
integrated with  
Use Me cabinets

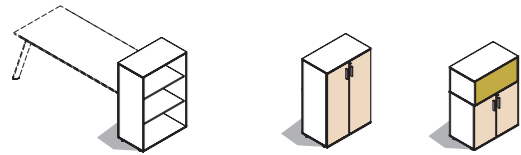

W 80  
D 46 – H 121,5

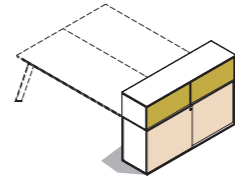

W 165  
D 46 – H 121,5

integrabile con  
contenitori Use  
Me / can be  
integrated with  
Use Me cabinets



Cabinet

W 50 / 100  
D 46  
H 83,1

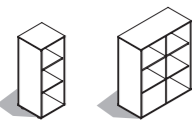

W 50 / 100  
D 46  
H 121,5

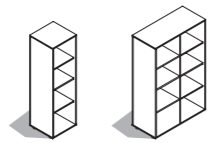

W 50 / 100  
D 46  
H 159,9 / 198,3



W 100  
D 46  
H 121,5 / 159,9

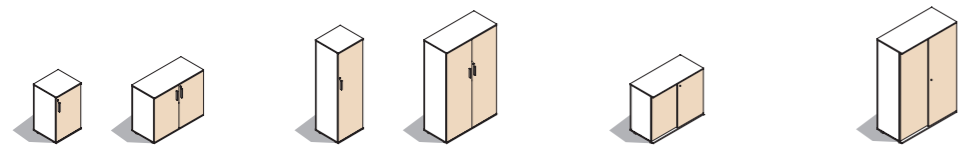

W 50 / 100  
D 46  
H 83,1 / 121,5

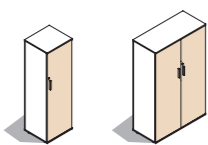

W 50 / 100  
D 46  
H 159,9 / 198,3



W 100 / 120 / 160  
D 46  
H 83,1 / 159,9

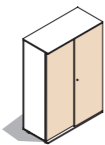

W 100 / 120 / 160  
D 46  
H 159,9 / 198,3

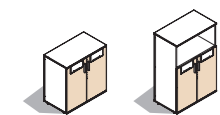

Recyclin point

W 100  
D 46  
H 83,1 / 121,5

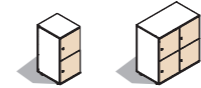

Personal locker

W 50 / 100  
D 46  
H 83,1

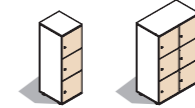

W 50 / 100  
D 46  
H 121,5

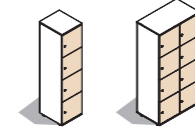

W 50 / 100  
D 46  
H 159,9

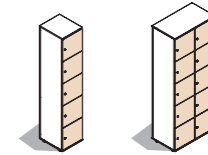

W 50 / 100  
D 46  
H 198,3

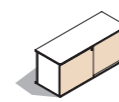

Hub

W 120 / 180  
D 46 – H 54,5

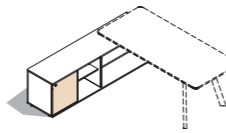

W 120  
D 46  
H 121,5 / 159,9

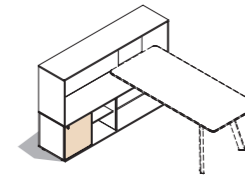

W 180  
D 46  
H 121,5 / 159,9

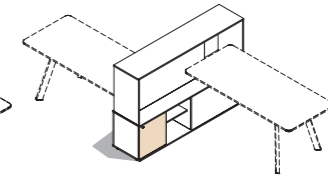

integrabile con  
contenitori Use  
Me / can be  
integrated with  
Use Me cabinets

# Libro Collection

Sinetica

IT · Libro è una libreria componibile giocata su moduli quadrati o rettangolari, con ripiani, schienali e box contenitori, per risolvere le più diverse esigenze di organizzazione del lavoro e dello spazio, in qualsiasi contesto.

EN · Libro is a modular bookcase which bases its structure on square and rectangular modules, as well as shelves, backs and box containers, thus allowing the organisation of work and space in any possible context.

FR · Libro est une bibliothèque modulaire qui joue avec des modules carrés ou rectangulaires, des tablettes, des dos et des niches avec portes, pour satisfaire les différentes exigences d'organisation du travail et de l'espace.

DE · Libro ist ein modulares Bücherregal, das seine Struktur auf quadratischen und rechteckigen Modulen sowie Regalen, Rücken und Kastencontainern aufbaut und so die Organisation von Arbeit und Raum in jedem möglichen Kontext ermöglicht.

ES · Libro es una librería modular compuesta por piezas cuadradas o rectangulares, estantes, respaldos y cajas archivadoras que dan solución a cualquier necesidad, en cualquier lugar.

RU · Модульный стеллаж, собираемый из элементов квадратной и прямоугольной формы, соответствует требованиям по организации офисного пространства: от зон работы сотрудников и кабинетов руководителей до архивов, зон ожидания и комнат для отдыха.





TYPE: Bookcase (h. 254,4 cm)



IT · Un nuovo modo di pensare alla libreria che da oggetto statico diventa sistema componibile capace di rinnovarsi in configurazioni basate su moduli, scaffali, schienali e contenitori. Una struttura arricchita da box contenitori con il sistema di apertura push & pull.

EN · Libro re-invents the way we think about office bookcases: from a static object, the bookcase itself turns into a modular system with the possibility of renewing its configuration with shelves, back panels and storage units. The structure is enriched by push & pull storage boxes.

FR · Une nouvelle façon de penser la bibliothèque, qui d'un objet statique devient un système modulaire qui se renouvelle dans configurations basées sur modules, niches ouvertes et fermées. Une structure enrichie de portes au système d'ouverture push-pull.

DE · Eine neue Art, über das Bücherregal nachzudenken, das aus einem statischen Objekt ein modulares System wird, das sich in Konfigurationen von Modulen, Regalen, Rückwänden und Elementen erneuern kann. Eine Struktur, die mit Boxmodulen mit Push&Pull Öffnungssystem angereichert ist.

ES · Libro es el nuevo modo de concebir la librería: a partir de una base estética, se crea un sistema que puede actualizarse con nuevos módulos y espacios para almacenaje. Una estructura formada por estantes y cajas para almacenar con sistema push-pull.

RU · Этот книжный шкаф для офиса, который из статического объекта превращается в модульную систему, способную обновляться в конфигурациях, основанных на модулях, полках, спинках и контейнерах. Эта структура имеет ящики для хранения с системой открывания push & pull.

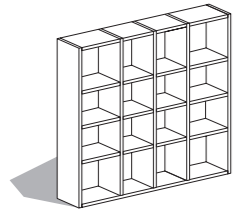

Bookcase

W 200  
D 39,4 – H 200,5

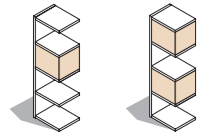

Module H 171,2

W 50  
D 39,4

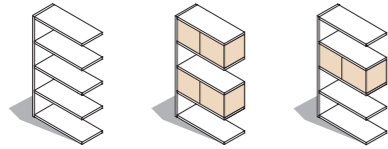

W 96,2  
D 39,4

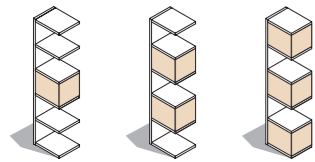

Module H 212,8

W 50  
D 39,4

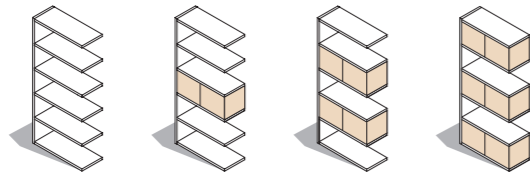

W 96,2  
D 39,4

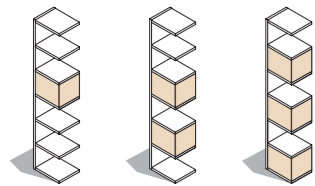

Module H 254,4

W 50  
D 39,4

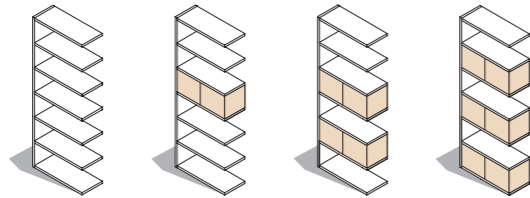

W 96,2  
D 39,4

# Captain Collection

by Baldanzi e Novelli

Sinetica

IT · Il mondo, la vita, gli scenari cambiano ogni giorno. È finito il tempo degli spazi e dei ruoli rigidamente definiti. La tecnologia apre infinite possibilità di connettersi, produrre, collaborare e creare, dovunque e in qualsiasi momento.

EN · Everyday world, life and scenarios constantly change. The time of the rigidly defined roles is over. Technology offers endless opportunities to connect, produce, collaborate and create; everywhere, anytime.

TYPE: Captain Play



TYPE: Captain Line / Captain Line Soft



TYPE: Captain Welcome



TYPE: Captain Heaven / Captain Heaven Soft



TYPE: Captain Join



TYPE: Captain Lounge



FR · Le monde, la vie et les situations changent chaque jour. Le temps des espaces et des rôles figés est révolu. La technologie ouvre des possibilités infinies de se connecter, produire, collaborer et créer, partout et à tout moment.

DE · Alltag, Leben und Szenarien ändern sich ständig. Die Zeit der fest definierten Rollen ist vorbei. Technologie bietet unendlich viele Möglichkeiten zum Verbinden, Produzieren, Zusammenarbeiten und Gestalten jederzeit und überall.

ES · El mundo, la vida, las situaciones cambian cada día. El tiempo de los espacios y los roles estrictamente definidos se acabó. La tecnología ofrece infinitud de posibilidades para estar conectados, ser productivos, colaborar y crear, en cualquier momento y en cualquier lugar.

RU · Мир, жизнь, сценарии меняются каждый день. Время жестко определенных пространств и ролей прошло. Технология открывает безграничные возможности для подключения, производства, сотрудничества и создания в любом месте и в любой момент.

# Captain Play

IT · Un concentrato di sapienza artigiana, tecnologia e design: Captain Play riesce a unire diversi stili per un incontro di idee che trova spazio ovunque. Un prodotto versatile che permette di creare diverse tipologie di seduta dal design personale, compatto e avvolgente.

EN · A concentration of artisan knowledge, technology and design: the Captain Play chair is a combination of different styles and ideas, which make it an ideal choice for different environments. A versatile product that allows to create different type of chairs maintaining a personal but cosy type of design.

FR · Un concentré de savoir-faire artisanal, de technologie et de design: Captain Play réussit à combiner différents styles qui trouvent leur place partout. Un siège polyvalent qui permet de créer différentes typologies avec un design propre, compact et enveloppant.

DE · Handwerkerwissen, Technologie und Design: Der Captain Play Stuhl ist eine Kombination aus verschiedenen Stilen und Ideen. Ein vielseitiges Produkt, mit dem verschiedene Stühle mit einem persönlichen, aber gemütlichen Design gestaltet werden können.

ES · Un concentrado de sabiduría artesana, tecnología y diseño: Captain Play supone una mezcla de estilos e ideas. Un producto versátil que permite crear diversas tipologías de asiento con un diseño propio, compacto y envolvente.

RU · В кресле Captain Play сочетаются умелая ручная работа, технология и дизайн, слились разные стилистические детали для единения идей в любых помещениях: коммерческих, офисных, конференц-залах и частных офисах специалистов.

TYPE: Play chairs and stools

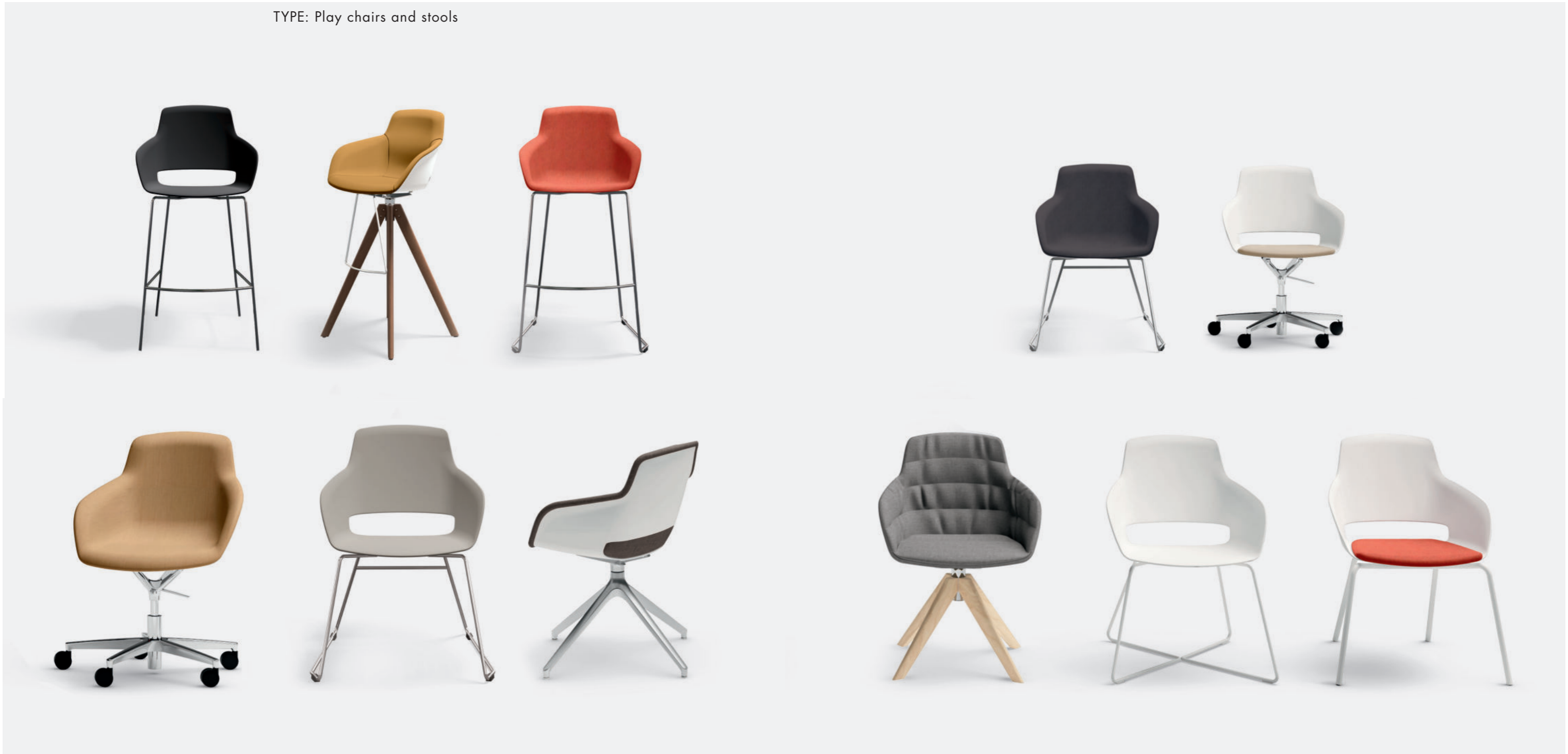

## Captain Play Collection

IT · Abbinando la scocca alle molteplici tipologie di basi non c'è praticamente limite alle soluzioni ottenibili. Giocando con un'ampia selezione di colori, rivestimenti e accessori, Captain Play risolve qualsiasi esigenza in casa, nel contract, in ufficio, negli ambienti collettivi e negli spazi outdoor.

EN · Combining the shell with the several available basis, it is possible to obtain a variety of items. Playing with a wide selection of colors, coatings and accessories, Captain Play turns into an ideal solution for every environment: at home, in the contract, in the office, in public areas, outdoors.

FR · Il est possible de combiner l'assise à différents types de pieds offrant ainsi des solutions pratiquement illimitées. Jouant avec un large choix de couleurs, revêtements et accessoires, Captain Play réponds à tous les besoins de la maison, du bureau, des espaces informels, publics et extérieurs.

DE · Kombiniert man die Schale mit den verschiedenen verfügbaren Grundlagen, ist es möglich, eine Vielzahl von Artikeln zu erhalten. Captain Play spielt mit einer großen Auswahl an Farben, Beschichtungen und Zubehör und wird zu einer idealen Lösung für jede Umgebung.

ES · La combinación con las diferentes bases permite crear una infinidad de resultados. La amplia selección de colores, tapizados y accesorios de Captain Play permite cubrir cualquier necesidad en casa, en la oficina, en espacios públicos y en exteriores.

RU · Комбинируя корпус с несколькими типами оснований, практически нет предела получаемым решениям. Играя с широким выбором цветов, покрытий и аксессуаров, Captain Play решает любые задачи дома, на работе, в офисе, в коллективе и на открытом воздухе.

TYPE: Play chairs





Chair

W 61 - D 58  
H 82 / seat H 44

W 61 - D 58  
H 82 / seat H 44

W 61 - D 58  
H 82 / seat H 44



Chair

W 61 - D 58  
H 83 / seat H 45

W 61 - D 61  
H 80÷90 / seat H 42÷52

W 61 - D 58  
H 83 / seat H 45

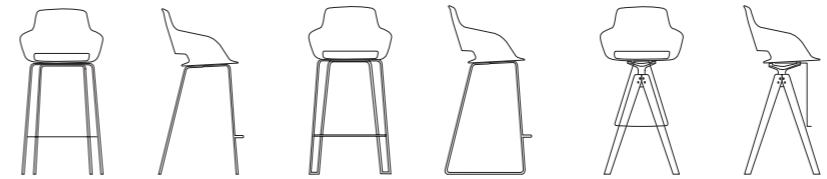

Stool

W 61 - D 58  
H 112 / seat H 74

W 61 - D 58  
H 112 / seat H 74

W 61 - D 58  
H 114 / seat H 76

# Captain Line/ Line Soft

IT · La sintesi tra comfort, funzionalità ed eleganza. Le molteplici possibilità di personalizzazione la sintonizzano con qualsiasi contesto, non solo in ufficio ma anche nel contract e negli ambienti residenziali. Nella versione Soft, le soffici imbottiture la rendono ancora più confortevole ed esclusiva.

EN · This chair is the ideal blend between comfort, functionality and elegance. The several possibilities of customisation make it perfect in every context: not only in the office, but also in the residential spaces. In its Soft version, the padding makes it even more comfortable and exclusive.

FR · La synthèse parfaite du confort, de la fonctionnalité et de l'élégance. Les nombreuses possibilités de personnalisation permettent de l'adapter tout type d'environnement, tel que bureau, public ou résidentiel. Dans la version "Soft", le rembourrage rend la gamme encore plus confortable et exclusive.

DE · Dieser Stuhl ist die ideale Mischung aus Komfort, Funktionalität und Eleganz. Die verschiedenen Anpassungsmöglichkeiten machen es in jedem Kontext perfekt: nicht nur im Büro, sondern auch in den Wohnräumen. In seiner weichen Version macht es die Polsterung noch komfortabler und exklusiver.

ES · La unión entre confort, funcionalidad y elegancia. Las múltiples posibilidades de elección permiten su adaptación en cualquier ambiente, en el trabajo o en casa. En la versión "Soft", la tapicería acolchada lo hace aún más confortable y exclusivo.

RU · Это стул с идеальным сочетанием комфорта, функциональности и элегантности. Его профиль разработан с мягкими линиями и концами, которые сообщают об утонченном стилистическом характере. Многие параметры настройки настраивают его в любом контексте, причем не только в офисе, но и в жилых помещениях.

TYPE: Line chairs





Captain Line  
/Line Soft Collection

Overview

Sinetica

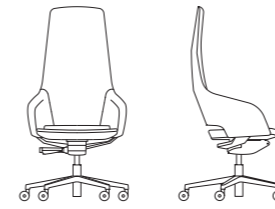

Line high back

W 69 - D 66  
H 122÷132 / seat H 42÷52

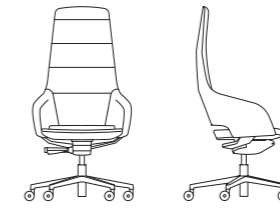

Line Soft high back

W 69 - D 66  
H 122÷132 / seat H 42÷52

-  elevabile / height adjustable
-  girevole / swivel
-  sincro / synchro



Line medium back

W 69 - D 66  
H 94÷104 / seat H 42÷52



Line Soft medium back

W 69 - D 66  
H 94÷104 / seat H 42÷52

-  elevabile / height adjustable
-  girevole / swivel
-  sincro / synchro





Line low back

W 63 - D 63  
H 75÷85 / seat H 42÷52



Line Soft low back

W 63 - D 63  
H 75÷85 / seat H 42÷52

-  elevabile / height adjustable
-  girevole / swivel



Line low back

W 63 - D 63  
H 77 / seat H 46



Line Soft low back

W 63 - D 63  
H 77 / seat H 46

-  girevole / swivel



# Captain Welcome

IT · Le forme arrotondate e armoniose sono il risultato di un lavoro di ricerca accurato e meticoloso. Frutto di un design sempre attuale che non sacrifica la comodità, Captain Welcome riscopre il suo fascino senza tempo grazie all'utilizzo di materiali di ultima generazione.

EN · The rounded and harmonious shapes are the result of an accurate and detailed research. With its evergreen design and comfort, and a perfect combination of the newest materials, Captain Welcome always keeps a characteristic timeless charm.

FR · Les formes arrondies et harmonieuses sont le résultat d'un travail de recherche soigné et précis. Fruit d'un design actuel au service du confort, le Captain Welcome révèle son charme intemporel grâce à l'utilisation optimale de matériaux de dernière génération.

DE · Die abgerundeten und harmonischen Formen sind das Ergebnis einer genauen und detaillierten Untersuchung. Mit seinem immergrünen Design und Komfort sowie einer perfekten Kombination der neuesten Materialien behält Captain Welcome immer einen charakteristischen zeitlosen Charme.

ES · Las formas circulares y armoniosas son el resultado de un trabajo de búsqueda riguroso y detallista. Fruto de un diseño atemporal que garantiza la comodidad, Captain Welcome refleja su encanto gracias al uso óptimo de materiales de última generación.

RU · Округлые и гармоничные формы являются результатом точной и тщательной исследовательской работы. Captain Welcome - это результат дизайна, который всегда актуален благодаря оптимальному использованию материалов последнего поколения.

TYPE: Welcome armchairs



IT · Accoglienti non solo per trascorrere un momento di relax e di comfort, ma anche per lavorare e comunicare, in sintonia con un concetto smart degli arredi e degli spazi. Captain Welcome riprende le forme della scocca della collezione Captain, vestendosi in diversi colori, in abbinamento a basi in legno o metallo.

EN · Not just comfortable to relax, but also ideal to work - always focusing on the concept of "smart" furniture and space -, Captain Welcome takes the shape of the shell typical of the Captain collection, and covers itself with different colors, joining wood or metal structures.

TYPE: Welcome armchair and sofa



FR · Fauteuils et canapés confortables pour se détendre, travailler ou échanger, en harmonie avec une conception "smart" des nouveaux espaces. Captain Welcome s'inspire des formes de la coque de la collection Captain montée sur pieds bois ou métal tout en s'habillant de différents revêtements.

DE · Die abgerundeten und harmonischen Formen sind das Ergebnis einer genauen und detaillierten Untersuchung. Mit seinem immergrünen Design und Komfort sowie einer perfekten Kombination der neuesten Materialien behält Captain Welcome immer einen charakteristischen zeitlosen Charme.

ES · Sillones y sofás acogedores y cómodos, ideales para descansar o trabajar. Captain Welcome se inspira en las formas envolventes de la colección Captain y se pueden tapizar en diferentes colores combinados con bases de madera metalizada.

RU · Удобные кресла и компактные диваны не только для того, чтобы расслабиться и отдохнуть, но и работать и общаться в гармонии с «умной» концепцией мебели и пространства.



Armchair  
W 79 – D 83  
H 79 / seat H 43



W 79 – D 83  
H 79 / seat H 43



Sofa  
W 148 – D 83  
H 73 / seat H 43



W 148 – D 83  
H 73 / seat H 43

# Captain Heaven/ Heaven Soft

IT · Prestigiosa ma al tempo stesso dinamica e trasversale, nella quale sentirsi accolti e protetti in qualsiasi ambiente e momento: in casa come poltrona relax o seduta per l'home entertainment, in ufficio come poltrona direzionale, oppure nella lounge di un aeroporto, nell'hôtellerie e in tante altre situazioni.

EN · Prestigious, but, at the same time, dynamic and versatile, welcoming and protecting the user in every environment and situation: at home, it plays the role of an armchair where to relax, or of a chair for leisure; in the office, it turns into a managerial chair. It is also perfect in an airport lounge, in hotels, and in several other different situations.

FR · Captain Heaven est un siège de prestige à l'utilisation à la fois dynamique et transversale. Il offre en toute situation une sensation d'accueil, de bien-être et de protection: à la maison comme siège de détente relax ou divertissant, au bureau comme siège de direction ou vidéoconférence, en espace lounge à l'aéroport, en hôtellerie et dans beaucoup d'autres situations.

DE · Repräsentativ, aber gleichzeitig dynamisch und vielseitig, um den Benutzer zu begrüßen und zu schützen: Zu Hause spielt er die Rolle eines Sessels, in dem er sich entspannen kann, oder eines Stuhls für die Freizeit; Im Büro verwandelt es sich in einen Chefessel. Es ist auch perfekt in einer Flughafenlounge, in Hotels.

ES · Dinámica y versátil, Captain Heaven ofrece una sensación de protección en cualquier lugar: en casa, como sillón de relax o de ocio; en la oficina, como asiento de dirección; en salas VIP de aeropuertos; en hoteles, y en otros muchos espacios.

RU · Благодаря установке динамик по бокам подголовника, Captain Heaven может стать самой настоящей мультимедийной станцией. Его обволакивающая форма имеет функцию визуальной и акустической изоляции, способствующей концентрации или отдыху.

TYPE: Heaven armchairs and ottoman



TYPE: Heaven Soft armchair and ottoman



IT · Grazie ai diffusori acustici ai lati del poggiatesta può trasformarsi in una vera e propria postazione multimediale. La forma avvolgente ha una funzione di isolamento visivo ed acustico, per favorire la concentrazione oppure il riposo, anche negli spazi collettivi.

EN · Thanks to the addition of two speakers at the sides of the headrest, Captain Play turns into a multimedia station. Its embracing shape functions as visual and acoustic isolation, favouring concentration as well as rest, even in public spaces.

FR · Grâce à deux diffuseurs acoustiques sur les côtés de l'appui-tête peut devenir un vrai poste multimédia. Sa forme enveloppante contribue à une isolation visuelle et acoustique, pour favoriser la concentration ou la détente même en milieu collectif.

DE · Dank der zusätzlichen zwei Lautsprecher an den Seiten der Kopfstütze wird Captain Play zur Multimedia-Station. Seine umfassende Form dient als visuelle und akustische Isolation und fördert sowohl die Konzentration als auch die Ruhe, auch im öffentlichen Raum.

ES · Gracias a sus dos altavoces en los laterales del reposacabezas, Captain Heaven Soft se transforma en un verdadero soporte multimedia. Su forma envolvente tiene función de aislamiento visual y acústico para facilitar la concentración y el descanso.

RU · Благодаря динамикам по бокам подголовника, это кресло может стать мультимедийной станцией. Его обволакивающая форма имеет функцию визуальной и акустической изоляции, способствующей концентрации или отдыху.



Poggiatesta con diffusori acustici e  
cuscino regolabile / Headrest with  
speakers and adjustable padded  
cushion



Heaven

W 80 - D 82  
H 124 / seat H 43



W 80 - D 82  
H 124 / seat H 43

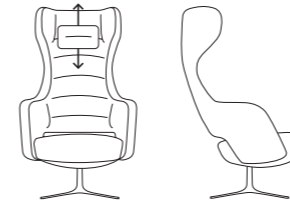

Heaven Soft

W 82 - D 76  
H 130 / seat H 45

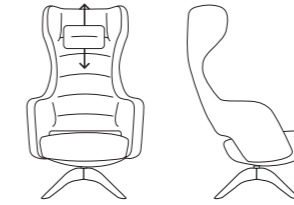

W 82 - D 76  
H 130 / seat H 45

diffusori  
acustici /  
speakers

diffusori  
acustici /  
speakers

cuscino  
regolabile /  
adjustable  
cushion



Ottoman

W 55  
D 70 - H 43



W 55  
D 70 - H 43

# Captain Join

IT · Unisce l'eleganza del design con un utilizzo informale e dinamico, negli ambienti contract e negli spazi di dimensioni più compatte, come quelli domestici. La palette di rivestimenti disponibili soddisfa qualsiasi gusto estetico e permette di creare una serie infinita di abbinamenti.

EN · It combines the elegance of the design with an informal and dynamic usage, both in the workplace and in smaller spaces - as, for instance, at home. The different available coatings satisfy every single aesthetic taste, and allows to create an endless series of combinations.

FR · Il allie l'élégance du design à une utilisation informelle et dynamique, dans des espaces publics et dans des espaces plus restreints, com me les espaces domestiques. La gamme de revêtements proposée satisfait à tous les goûts esthétiques et permet de créer une gamme presque infinie de combinaisons.

DE · Es kombiniert die Eleganz des Designs mit einer informellen und dynamischen Nutzung, sowohl am Arbeitsplatz als auch in kleineren Räumen - wie zum Beispiel zu Hause. Die verschiedenen verfügbaren Beschichtungen erfüllen jeden ästhetischen Geschmack und ermöglichen eine unendliche Reihe von Kombinationen.

ES · Combina un diseño elegante con un uso informal y dinámico en espacios públicos y en otros más pequeños, como en casa. La gama de revestimientos disponibles satisface cualquier estilo y permite crear una infinidad de combinaciones.

RU · Сочетает в себе элегантность дизайна с неформальным и динамичным использованием в условиях офиса и в более компактных помещениях, таких как бытовые. Палитра доступных покрытий удовлетворяет любой эстетический вкус и позволяет создавать практически бесконечные серии комбинаций.

TYPE: Join armchair



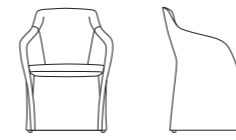

Armchair  
W 62 - D 56  
H 82 / seat H 44

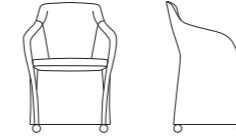

Armchair with wheels  
W 62 - D 56  
H 84 / seat H 46



TYPE: Lounge armchairs



IT · Forme elegantemente leggere, eppure comode e riposanti, ma al tempo stesso essenziali, creano una sensazione di piacevole intimità, sia in ufficio che nell'ambiente domestico. La fuga di luce tra sedile e schienale, infine, costituisce un particolare stilistico che esalta ulteriormente l'estetica complessiva.

EN · Both in the office and in a domestic environment, its elegantly light shapes, comfortable and relaxing, but essential at the same time, provide the user with a feeling of pleasant intimacy. The soft light between the seat and the seatback is a stylistic element that further exalts its comprehensive aesthetic.

FR · Des formes élégantes et fluides, à la fois confortables et reposantes, créent en même temps un sentiment de bien-être et d'intimité au bureau comme à la maison. L'espace entre l'assise et le dossier est un détail de style qui renforce encore l'esthétique générale.

DE · Sowohl im Büro als auch in der häuslichen Umgebung vermitteln die leichten Formen, die komfortabel und entspannend sind, gleichzeitig aber unerlässlich, dem Benutzer ein Gefühl angenehmer Intimität. Das weiche Licht zwischen Sitz und Rückenlehne ist ein stilistisches Element, das seine Ästhetik noch verstärkt.

ES · Formas ligeras, cómodas y relajadas, y al mismo tiempo simples, crean una sensación de bienestar y privacidad, en casa o en la oficina. La tenue luz entre el asiento y el respaldo constituye un rasgo estilístico y hace destacar su estética general.

RU · Элегантные, легкие формы, удобные и спокойные, но в то же время практичные, создают ощущение приятной близости как в офисе, так и дома. Наконец, свет между сиденьем и спинкой - это стилистическая деталь, которая еще больше улучшает общую эстетику.



Armchair

W 83 – D 86  
H 91 / seat H 44

W 83 – D 86  
H 91 / seat H 44

W 83 – D 86  
H 91 / seat H 44

# Multitask Collection

Sinetica

IT · Un'alternativa completa per l'arredo dei luoghi destinati al contatto con il pubblico. L'organizzazione degli spazi di ospitalità così diventa più semplice e consente di ottenere risultati di pregio in tutti gli ambienti lavorativi destinati all'accoglienza.

EN · This is a complete alternative for the public areas. Organising hospitality becomes extremely simple and allows to obtain prestigious results in all of the working environment for the welcoming of the visitors.

FR · Une alternative complète pour l'ameublement des espaces publics. L'organisation des espaces d'accueil devient simple et efficace et consentit d'obtenir des résultats élégants et précieux dans tous les milieux destinés à la réception.

DE · Dies ist eine komplette Alternative für die öffentlichen Bereiche. Die Organisation der Gastfreundschaft wird extrem einfach und ermöglicht es, in der gesamten Arbeitsumgebung prestigeträchtige Ergebnisse für die Begrüßung der Besucher zu erzielen.

ES · Una alternativa completa para la decoración de espacios de colectividad. La organización de dichos espacios llega a ser más sencilla y permite obtener resultados de valor en todos los entornos de trabajo destinados a la recepción.

RU · Полная альтернатива для обустройства мест, предназначенных для контакта с общественностью. Таким образом, организация этих мест приема становится проще и позволяет получать ценные результаты во всех приемных рабочих средах.



TYPE: Coffee tables (h. 35 cm)

TYPE: Tables (h. 74 / 110 cm)

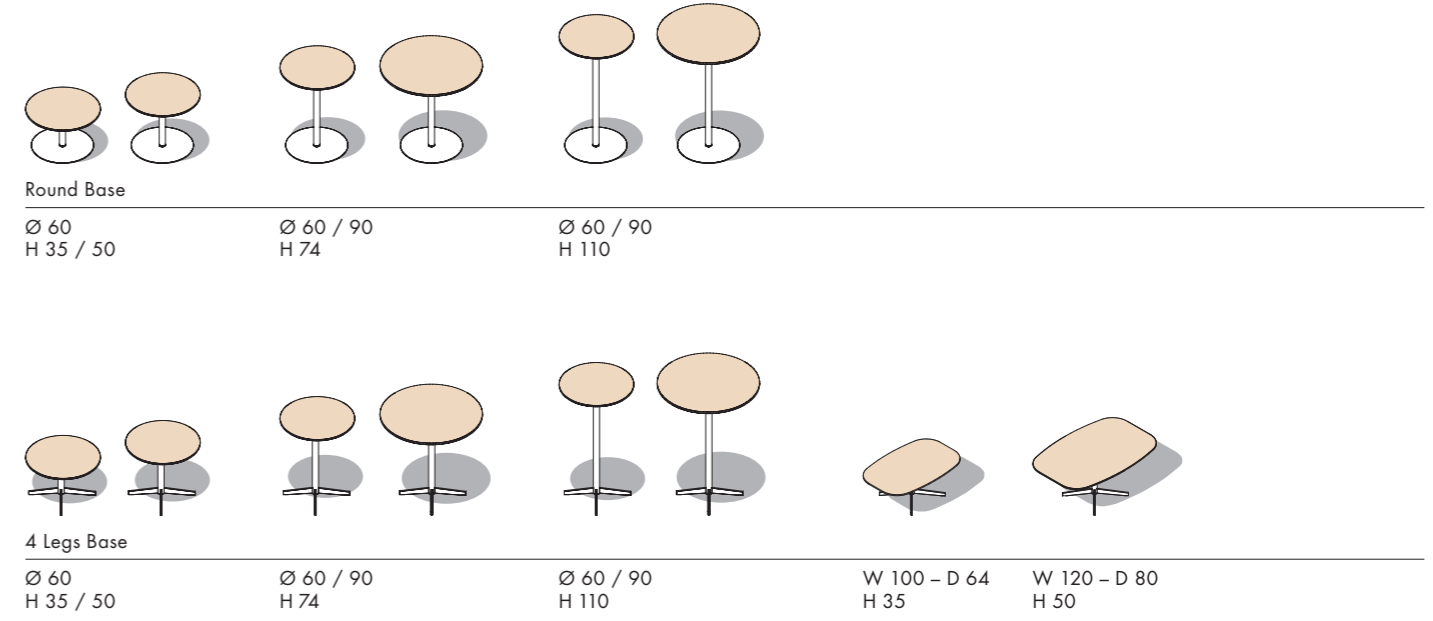

IT · La reception è l'ambiente che esprime per primo la personalità e l'immagine di un'azienda: con il suo rigoroso minimalismo, Factory comunica un'atmosfera di raffinata funzionalità. Linee pulite, superfici ampie e volumi di altezza diversa, accolgono i visitatori e soddisfano tutte le esigenze degli operatori.

EN · The reception is the very first environment displaying both of the personality and the image of a company: with its strict minimalism, Factory creates an atmosphere of fine functionality. Smooth lines, wide surfaces, and volumes of different heights welcome visitors and meet the needs of the operators.

FR · L'accueil est le premier espace qui traduit la personnalité et l'image d'une entreprise : le minimalisme rigoureux de Factory communique une atmosphère de fonctionnalité raffinée. Des lignes épurées, de grandes surfaces et des volumes de différentes hauteurs accueillent les visiteurs et répondent à tous les besoins des opérateurs.

DE · Die Rezeption ist die allererste Umgebung, die sowohl die Persönlichkeit als auch das Image eines Unternehmens zeigt: Factory schafft mit seinem strengen Minimalismus eine Atmosphäre feiner Funktionalität. Glatte Linien, breite Flächen und Volumen in verschiedenen Höhen begrüßen die Besucher und erfüllen die Bedürfnisse der Bediener.

ES · La entrada muestra la personalidad y la imagen de una empresa. Con su riguroso minimalismo, Factory ofrece un ambiente de funcionalidad refinada. Líneas uniformes, superficies amplias y volúmenes de diferente altura acogen a los visitantes y satisfacen cualquier exigencia.

RU · Приемная зона— это место, где создается первое представление об индивидуальности и образе компании. Строгий минимализм Factory дарит атмосферу утонченной функциональности. Прямые лаконичные линии и безупречный дизайн встречают посетителей и соответствуют всем требованиям сотрудников.



TYPE: Reception (h. 113,2 cm)

TYPE: Reception (h. 113,2 cm)



IT - Factory è la reception che permette di dare alla propria azienda un'immagine chiara, decisa, senza compromessi. Factory dispone di piani in legno, melaminico e laccato su cui spicca un top in vetro temperato.

EN - Factory is the reception which is able to provide the company with a clear image of itself: the toughened glass top stands out its wood, melamine or lacquered tops.

FR - Factory est la banque d'accueil qui permet de donner à son entreprise une image claire. Factory dispose de finitions bois, mélamine et laque associées aux tops en verre trempé

DE - Factory ist die Rezeption, die dem Unternehmen ein klares Bild von sich geben kann: Die Platte aus gehärtetem Glas zeichnet sich durch Holz-, Melamin- oder lackierte Platten aus.

ES - Una entrada con Factory ofrece a la empresa una imagen clara y decidida. Esta colección dispone de acabados en madera, melamina y lacado, y se complementa con una superficie de cristal templado.

RU - Factory - это прием, позволяющий составить о вашей компании четкое, решительное впечатление без компромиссов. Factory располагает поверхностями из дерева, меламин и лака, на которых размещается топ из закаленного стекла.

## Factory Collection

IT · Destinato al contatto con il pubblico in locali quali hall di alberghi, uffici direzionali e sale conferenza. Le sue caratteristiche esclusive fanno di Factory il banco reception che regala ad aziende e brand un tono di raffinata autorevolezza.

EN · Factory - with its unique characteristics, providing companies and brands with an atmosphere of prestige - has been specifically designed for public places such as hotel receptions, executive offices and conference halls.

FR · Destiné au contact du public dans des locaux tels que les halls d'hôtel, les bureaux de direction et les salles de conférence. Ses caractéristiques exclusives font de Factory le bureau d'accueil qui offre à l'entreprise une image raffinée.

DE · Factory - mit seinen einzigartigen Eigenschaften, die Unternehmen und Marken eine prestigeträchtige Atmosphäre verleihen - wurde speziell für öffentliche Bereiche wie Hotelempfänge, Chefbüros und Konferenzsäle konzipiert.

ES · Destinado para espacios públicos, como entradas de hotel, despachos de dirección y salas de reuniones. Sus características exclusivas hacen de Factory un mostrador de entrada que confiere autoridad.

RU · Предназначен для контакта с публикой в таких местах, как гостиничные холлы, административные помещения и конференц-залы. Регистрационная стойка Factory задает компаниям и брендам тон власти.

TYPE: Reception (h. 113,2 cm)





1 IT *Top vetro ad angolo*  
 EN *Corner glass top*  
 FR *Top en verre*  
 DE *Eckiger Theken Aufsatz*  
 ES *Sobre angulo en cristal*  
 RU *Угловое стеклянная столешница*

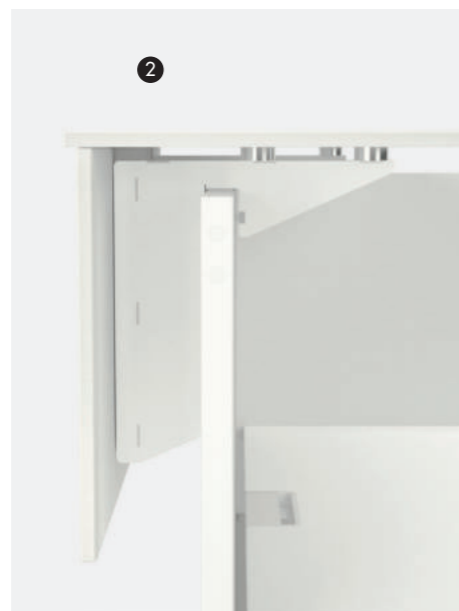

2 IT *Sistema fissaggio top vetro*  
 EN *Glass top fixing system*  
 FR *Fixation top en verre*  
 DE *Befestigungssystem mit Glasplatte*  
 ES *Sistema fijación top cristal*  
 RU *Система крепления стеклянной столешницы*



3 IT *Modulo visitatore*  
 EN *Visitor module*  
 FR *Module visiteur*  
 DE *Besuchermodul*  
 ES *Módulos confidente*  
 RU *Модульная визитница*

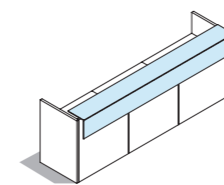

Reception  
 W 107,6 / 207,6 / 307,6  
 D 84 – H 113,2

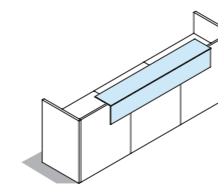

W 307,6 / 407,6  
 D 84 – H 113,2

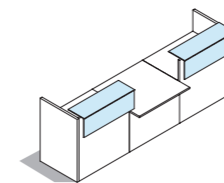

Reception with visitor unit  
 W 307,6  
 D 103,6 – H 113,2

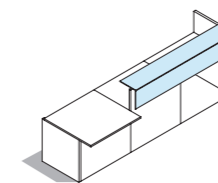

W 307,6  
 D 103,6 – H 113,2

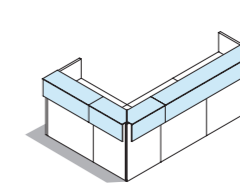

Reception with corner unit  
 W 287,8  
 D 187,8 – H 113,2

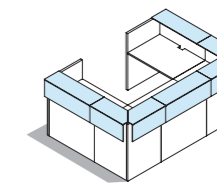

W 268 / 368  
 D 187,8 – H 113,2



# Certificazioni

## Certifications

Sinetica è un brand di Faram 1957 S.p.A. La continua ricerca di soluzioni e approcci sostenibili ha permesso a Faram di ottenere importanti certificazioni, tra le altre: **SA8000, ISO 14001, ISO 50001 e FSC.**

Sinetica a brand of Faram 1957 S.p.A. Ongoing research for sustainable solutions and approaches has earned Faram 1957 the award of the most important certifications such as **SA 8000, ISO 14001, ISO 50001 and FSC.**

Faram è socio Green Building Council, utilizza componenti a base legno approvvigionati da fornitori certificati **FSC** e contribuisce con i propri prodotti alla realizzazione di edifici ecocompatibili e certificati **BREEAM, LEED, WELL Building.**

Faram 1957 is a member of the Green Building Council uses wood-based components from **FSC** certified suppliers and contributes through its products to the construction of buildings certified to **BREEAM, LEED and WELL Building Standards.**

**VERNICIATURA** / Tutti gli elementi del sistema realizzati in lamiera pressopiegata od in estruso di alluminio vengono verniciati a polveri epossipoliestere, applicando uno spessore di vernice compreso tra i 50 ed i 90 micron per le vernici lisce, e tra i 55 ed i 100 micron per le vernici goffrate. Sono eseguite le seguenti prove da laboratorio accreditato:  
**UNI ISO 9227** - Prove di corrosione in atmosfere artificiali. Prove in nebbia salina  
**UNI EN ISO 1520** - Prodotti verniciati. Prova di imbutitura  
**UNI 9240** - Determinazione dell'adesione delle finiture al supporto mediante prova di strappo.

**COATING** / All the system elements in press-bent sheet metal or extruded aluminium are epoxy-polyester powder coated, applying a 50 to 90 micron coat for smooth paints, and a 55 to 100 micron thickness for embossed surfaces. The following tests are carried out by accredited laboratories:  
**UNI ISO 9227** - Corrosion tests in artificial atmospheres. Salt spray tests  
**UNI EN ISO 1520** - Varnished products. Cupping tests  
**UNI 9240** - Pull off test for surface adhesion



**SOSTENIBILITÀ: BREEAM, LEED e WELL**  
 FARAM si è dotata di specifiche procedure per commesse legate a progetti in fase di certificazione LEED® e/o WELL.

**SUSTAINABILITY: BREEAM, LEED and WELL**  
 FARAM has adopted special procedures for orders linked to projects undergoing LEED® and/ or WELL certification.

**NORMATIVE DI RIFERIMENTO**

- \* ISO 12150 - vetri temprati
- \* ISO 12543 - vetri stratificati
- \* ISO 12600 - prova al pendolo per resistenza meccanica del vetro
- \* UNI 7697 - sicurezza del vetro
- \* EN 120 - bassa emissione di formaldeide

**REFERENCE STANDARDS**

- \* ISO 12150 - toughened glass
- \* ISO 12543 - layered glass
- \* ISO 12600 - pendulum impact test on glass
- \* UNI 7697 - glass safety
- \* EN 120 - low formaldehyde emissions

## **Sinetica**

Giorgia Dissera  
Laura Franceschet  
Roberto Bruniera

## **Sinetica a brand of**

© FARAM 1957 S.p.A.  
All rights reserved.

**Faram 1957 si riserva il diritto di modificare, integrare o eliminare in qualunque momento e senza preavviso, le caratteristiche tecniche e i modelli illustrati in questo catalogo.**

**Faram 1957 è un marchio registrato: i modelli rappresentati in questo catalogo sono protetto da brevetti depositati; tutti i diritti di riproduzione, anche parziale, sono di esclusiva proprietà di Faram 1967 e solo previo consenso potranno essere utilizzati. i colori illustrati nel presente catalogo potrebbero non corrispondere a quelli originali. per un riscontro accurato del colore contattare Faram 1957.**

Faram 1957 reserves the right to change, supplement or eliminate at any time and without notice the technical features and models illustrated in this catalogue.

Faram 1957 is a registered trademark: the models represented in this catalogue are protected by registered patents; all reproduction rights, even partial, are the exclusive property of Faram 1957 and may only be used with prior consent.

The colors shown in this catalogue might not correspond to the original ones. For accurate colour matching, contact Faram 1957.

## **Sinetica a brand of FARAM 1957 S.p.A.**

Via Schiavonesca, 71  
31040 Giavera del  
Montello  
Treviso, Italy

T +39 04 22884808  
faram@faram.com

**faram.com**