

**YOUR  
HUSH  
YOUR  
WAY**

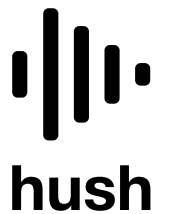



## **What is our Hush Concept Catalog about?**

We wanted to understand how our people think about Hush pods. So we connected with leading professionals in every field that touches talent management and office design. We asked questions, and we listened. What follows is the insight we captured. For those who think radically about performance, well-being, and the undeniable role that design plays in how we work, our concept catalog is a worthwhile read.

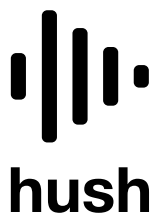

# We all work hard. The office should, too.

## JULIA - PROJECT MANAGER

**Do you want to spend less time finding focus and more time producing?**

The high-level status report is due tomorrow morning. So far, you've met each milestone in stride. You and your team are on track. But every day, so much energy is lost fighting distraction. Constant noise and other stimuli in your open office leave you emotionally exhausted by the end of the week. Hush offers a better way.

See pages 8-23

## YAO MING - SALES CONSULTANT

**Do you wish you felt more comfortable in the office, as an on-the-go employee?**

You're a mobile employee. You spend more time on the road than you do in the office. The time you spend on-site is, however, indispensable, because you only have a few hours each week to touch base with colleagues and hit outreach targets. Hush is for people like you who need to get maximum output out of this minimal amount of time.

See pages 24-37

## CLAIRE - HR MANAGER

**Do you dream of an office space that attracts and nurtures talent?**

The fight for talent intensifies with each quarter. You need free-thinking people to drive the kind of differentiation that will put your team in a class of its own. What if you could continually tweak your office space to draw these one-in-a-million performers you need? Hush is the missing piece.

See pages 38-47

## SARA - GENERAL MANAGER

**How do we satisfy all working styles?**

Your sales team takes a lot of private calls and meets only twice a week. Your marketing team holds brainstorms every other day and spends a ton of time working solo. Your design team spends the majority of their week alone, drafting. You need spaces for collaboration, privacy, and everything in between. How do you satisfy all these needs?

See pages 48-53

## BRAD - FACILITY MANAGER

**Is it possible to build an office space that adapts? And at a reasonable cost?**

You have a limited budget for layout changes. The problem is, employee needs fluctuate: teams shift; mobile workers hop in and out; individual work patterns have a life of their own. Your entire workforce is in a constant state of change. The office space needs to keep up. Hush is how.

See pages 54-61

## ZACHARY - ARCHITECT

**What if you could future-proof your client's office?**

Your client wants a functional, modern space. But their needs shift rapidly because work tasks, patterns, and flows are continually evolving. What if you fit out the floorplan with a variety of work pods that catered brilliantly to these evolving tasks, patterns, and flows? Let's call it what it is: future-proofing the office through an inherently flexible fix.

See pages 62-77

## KEVIN - LANDLORD

**If you could cut your build-out work in half, how would that affect your income?**

Tenants are more confident taking on longer leases when the space they are moving into is flexible. For this reason, modular, mobile work pods have taken the place of conference and meeting rooms. When you invest in pods, not only do you set yourself up to win those long-term tenants, but your space is move-in ready, and your cashflow recovered in weeks rather than months.

See pages 78-83

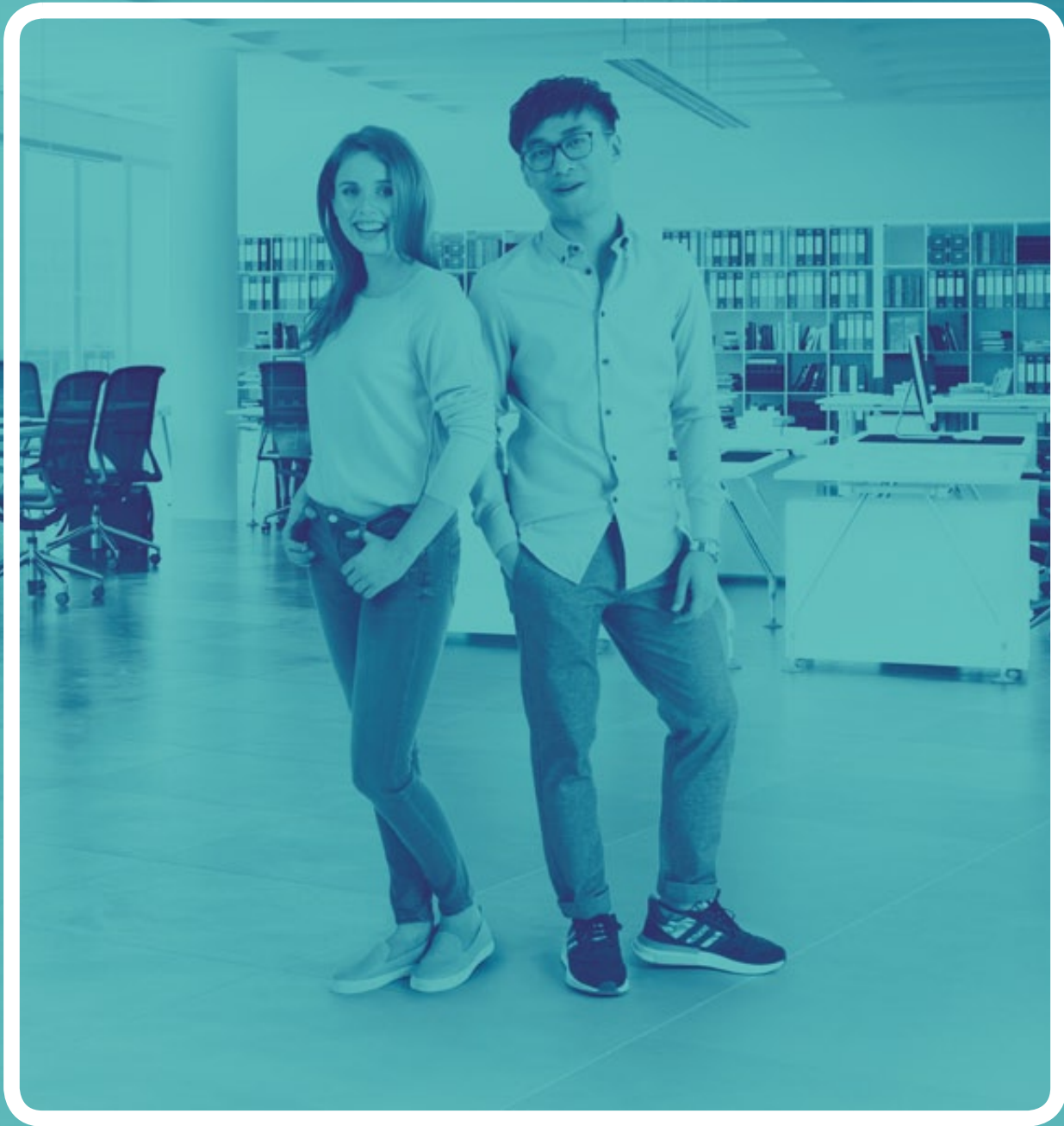

CHOOSE HOW YOU WORK

# Hush is the solution for any team that struggles to maintain workplace functionality as they grow.

In our modern world, with excessive stimuli, information-overload, and mounting work demands, concentration is everything. Hush gives employees an ideal work environment to find it, whether individually or with a group. The mission of each pod is to provide this essential support needed to perform at the highest, happiest level.

Hush gives people control over their environment, which translates into control over their concentration and, ultimately, their growth. Control lends freedom — freedom to work when, where, and how one wants to. Most importantly: the freedom of having absolute comfort and focus within one's unique workflow.



**We created Hush  
to make work make sense again.**

FREEDOM  
HELPS ME  
MEET  
MY GOALS

## **JULIA**

Project Manager

Strong communicator and team chief  
with a superhuman talent for keeping  
cool under pressure.







Communication is essential to an agile approach. We've got to stay on the same page, in real-time, to keep pace with one another.

# MY HUSH MY DAY

## HUSH IS A KEY PLAYER IN TIME MANAGEMENT

If I didn't have the right environment to support each type of task, I would be constantly losing energy in a struggle to maintain focus. Each pod sets a different tone for a different task, which is just what I need — I can rotate through pods and stay attentive and alert.

## DYNAMISM & VARIABILITY

If there is one word to describe my work, that word would be dynamic. Each project phase is wildly different from the next. And, time and again, we change course entirely.



Each Hush pod is sized and designed for a distinct work task. Meeting pods for brainstorming sessions, interviews, and small group collaborations. Solo pods for private calls and video conferences. And semi-open pods for a more lively team meet. These semi-open models are a hybrid of 'open' and 'closed' that allows energy to flow through and vitalize impromptu meetings.

**hushwork**

**20** | **2**  
emails | hours

The projects we take on are complex. Unpacking lengthy status reports from multiple teams takes an enduring focus. Solo pods support this kind of focus.



## JULIA'S DAY IN NUMBERS



**hushmeet**

**3** | **2**  
meetings | hours

We hold brainstorming sessions nearly every day. In a very real sense, they seed our opportunity to succeed in the long run. HushMeet is an ideal space for this collaborative effort.



## hushphone

**10** | **1**  
 phonecalls | hours

I touch base with stakeholders on a weekly basis. I can relax in my hushPhone and focus on maintaining the right tone and presence through each brief but important call.

“

My office needs to be dynamic to support the wide variety of tasks that go into planning, executing, and closing successful projects.



## hushmeet.open

**2** | **1**  
 breaks | hour

Our hushMeet.open creates an informal environment for relaxation. Within it, my colleagues and I can take breaks, regroup, and return to our work with fresh energy.



# SHIFT GEARS FOR EACH NEW TASK

“ When it comes down to it, my job is simple. I define the goal and achieve it through a smart, flexible plan.

With multiple teams and projects, however, the work of it takes more than basic management and leadership skills — it takes stamina. I can't simply 'juggle' tasks. I have to meet each one with my full presence. Hush helps by giving me a variety of environments to move through every day. Because each pod is unique, changing pods is like shifting gears into the next task. And shifting gears helps me maintain that full presence.

**hushphone**



The perfect place for a video conference

hushphone











hushwork.sit&stand



Without a flexible office, I wouldn't be able to lead our teams in hitting each major project milestone.





# WORK HOW YOU WANT. **YOUR WAY**



Work in a sitting or standing posture



We weren't designed to sit for eight hours each day. The height-adjustable desks within our work pods empower my team to move more — and to rediscover the energizing effect of movement itself.



### **Desk Height Adjustment within 2 seconds**

Desk with manual adjustment countertop height, in the range of 670-1250 mm / 26-49 in.





## FOCUS THROUGH MOVEMENT

“ A Hush office is characterized by movement and focus. I love to watch my teams rotate through pods each day, optimizing their work patterns. Rather than deskbound, they are moving — and movement helps them maintain this focus. Our status reports show that this shift toward movement has improved our productivity as a team.

### **hushmeet**



A perfect place for  
team meetings

hushmeet



## A VITALIZED **WORKFLOW**

Our hushMeet pod is a working space well-suited for brainstorming and scrums. It's the perfect size for project teams to connect and make sure they're on track.

hushmeet



MY  
CLIENTELE  
ARE MY  
MOTIVATION

## **YAO MING**

Sales Consultant

Listener, communicator, and relationship-builder. Match-maker between solutions and unique client needs.







“ Hush makes me feel welcome and comfortable during the short amount of time I spend at the office.

# MY HUSH MY WORKFLOW



Because I am in and out of the office each day, the time I spend there is invaluable. I only have a few hours to align with my team, update my supervisors, and hit my outreach targets. That's why I'm so finicky about my environment — it needs to help me perform at a high level.

## I AM ON-THE-GO THE MAJORITY OF MY WEEK

**connecting with and nurturing  
new prospects.**

And though I only spend a small share of time in the office and I don't actually have my own desk, when I'm there, I feel comfortable in my Hush pods. I can concentrate on multi-faceted proposals and needle-moving emails easily because the pods support deep focus.

It's easy to represent a product when the solution is a godsend for your own workflow. Hush works for my clients, and it also works for me.





The single pods are a space to connect with remote clientele. They are brilliantly soundproofed and don't block wifi, so my connection is always strong. They also come with a fold-away standing-height table, which is perfect for someone like me who likes to stand through calls and teleconferences.



## hushphone



A perfect place for trade negotiations



### Acoustics

more info on pages 88-91





hushphone

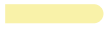

# THE RIGHT ENVIRONMENT TO KNOCK OUT WORK



## Functional solutions

Lighting, ventilation system, fold-away laptop table, 230V/110V socket, and USB.





## Comfort and ease of use

HushPhone's ergonomic armrest, motion sensor light, and glass paneling make it easy-to-use and comfortable.

Camaraderie really fuels my ambition. So I like to feel connected to my team even when I'm working solo. Because its glass panels permit some visibility into the office, hushPhone is perfect for me for this reason — I can hop in and zone into my work but still feel connected.



# FOCUS WITHIN EASY REACH

## hushwork



The perfect space  
for work requiring deep  
concentration

HushWork is an ideal space for deep work. With ample power sockets and strong wifi signal, connection is never lost, interrupting concentration.



**Efficient ventilation**  
more info on page 113

hushwork







# HUSH IS YOUR WORKSPACE

Hush gives you control over the lighting, ventilation, desk height, and music at your workspace. It replaces stress with comfort.



Comfort of use





### Functional solutions

Each Hush pod is built with features that make their environment 100% adjustable. Plug in your ambient sounds to elicit flow. Or turn up the fans, tweaking ventilation to suit your preferences. Sensitive to light? Go ahead and dim them. Prefer to work standing up? Solo pods come with a sit-stand desk.



# LIMITED SPACE? NO PROBLEM

## hushTwin



An efficient  
use of space

HushTwin is made by two conjoined pods, each with their own sofa, desk, lighting, and ventilation. It's larger than hushPhone but smaller than hushWork; both 'halves' provide the essential amount of space to work — no more, no less. For teams who need multiple private work areas in their small office, hushTwin delivers in its efficient use of space.

hushTwin





I WANT TO  
WIN AND  
GROW TALENT  
THE SMART  
WAY

## **CLAIRE**

HR Manager

People-focused forward-thinker with an eye on the well-being component of performance.







# CREATING

## AN UNPARALLELED WORKPLACE EXPERIENCE THAT WINS TALENT

### An interview with Claire

“ The workplace experience either fosters or inhibits the kind of environment needed to reach our most ambitious goals as HR personnel. And workplace experience boils down to good office design.

## MY HUSH MY TALENT

### What role does the modern office play in modern work?

With talent at a premium, the workplace experience represents a selling point. An office that serves both performance and well-being will win the high-performing employee we all dream of. That being said, the office plays an unsubstitutable role in our work. It is both a physical space for collaboration and an experience that can support our best work from our happiest frame of mind.

### How can we improve the workplace experience?

By improving the fundamentals. Lighting, air quality, color, and acoustics. These fundamentals underpin physical and emotional well-being — and well-being underpins performance in every aspect. We should also provide more alternative work environments. Things like huddle spaces, lounges, cafes, and solo work pods — spaces in which people can approach their work from a fresh angle, or unplug from it entirely. People benefit from a frequent change of scenery, never getting lost in the weeds of work.

### Can you elaborate on the value of providing more alternative work environments?

People want more control over how they work. According to Savills's latest research, 70% of employees who feel like they have no control over their office's design are unhappy at work. Where employees spend more time in alternative work environments than at their actual desks are happy.

### What constitutes an alternative work environment?

Breakout spaces, quiet pods, relaxation zones, etc.. Any atypical space to work or hang out. Variety gives people the freedom to work as they work best, finding the privacy, quiet, and sense of ownership the open office took away. To bring it full circle, 78% of happy workers plan to stay with their employer for more than ten years. This statistic represents the connection between office design and turnover, and this is why I've shifted the focus of my workplace strategy to improving the office space.





hushmeet.S

# ENERGIZED MEETINGS

“ Soundproofed collaborative work pods provide the ideal acoustic environment for teams to hold vibrant, energized meetings without concern over bothering colleagues.

## hushmeet.S



Ideal for collaborative meetings



**Acoustics**  
more info on pages 88-91

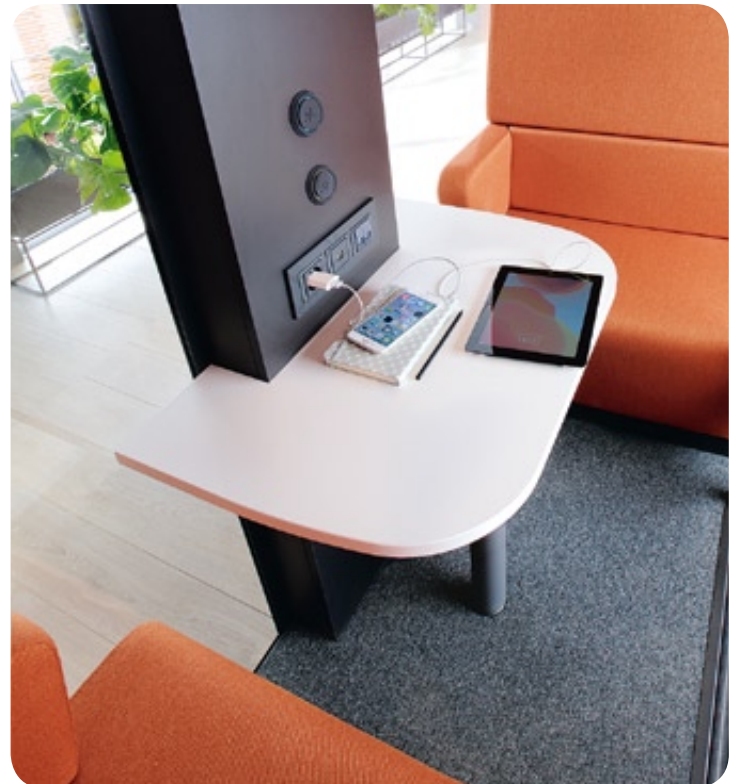



## DRIVING TEAM **SUCCESS**

Hush pods work because different pod sizes and styles create different kinds of atmospheres. The variety gives my employees choices, which translates into control over how they work.



# THE WAR FOR TALENT IS BRUTAL

The biggest challenge facing high-performing organizations continues to be attracting and retaining prime talent. Nearly 50% of employees plan to change jobs within the next five years.\*

How long do you expect to stay with your current employer?

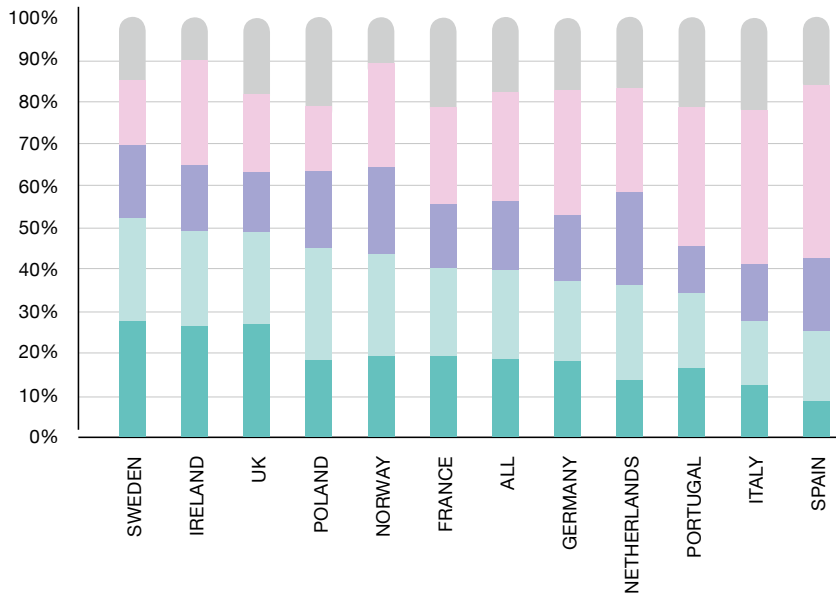

## Employees want a better workplace experience

The office plays a strong role in these statistics. According to Savills's What Workers Want 2019 report, the top factors that people would change about their job if they could relate to the design of the office: both their personal workspace and the shared office space.

- Don't know
- More than 10 years
- More than 5 years, up to 10 years
- More than 2 years, up to 5 years
- Less than 2 years

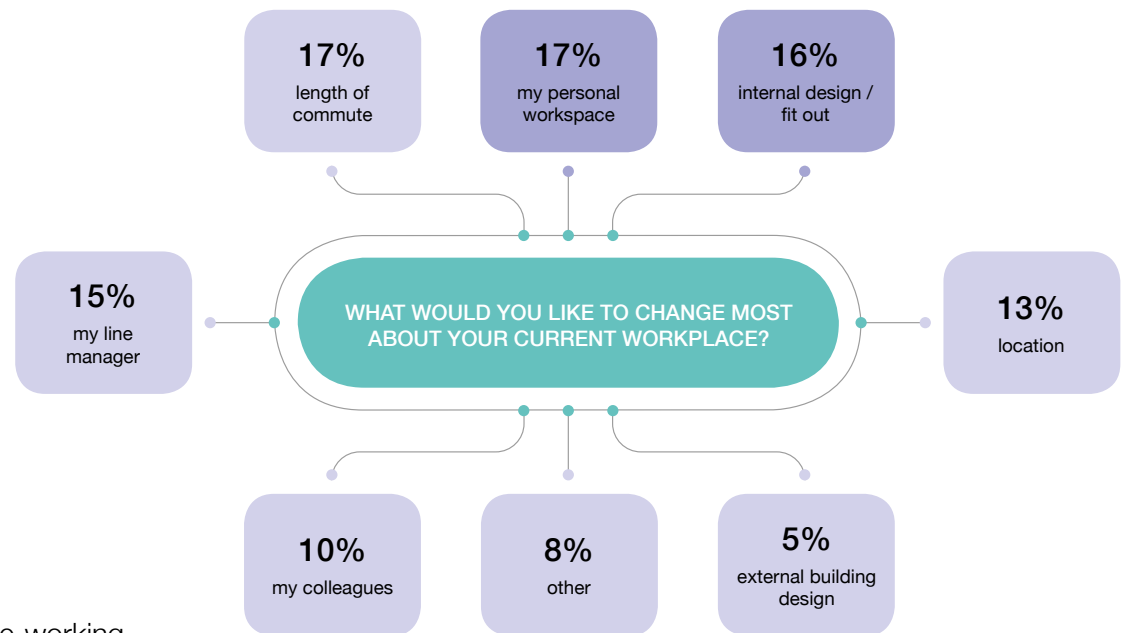

## The role of the workplace for a remote workforce

Despite the trend toward flexible remote working options, the physical office isn't going anywhere. People need human connection to feel the significance of their work. The physical office now represents an asset that drives engagement and productivity while embracing the whole human — including their need for emotional wellness.

The takeaway is that the workplace plays a critical part in preventing employee turnover and attracting new talent.

\*Savill's (2019) , What workers want: Europe, p.7



Employees who enjoy their environment at work are less likely to leave. The key is creating a workplace experience that attracts and supports the right talent.



# I IMPLEMENT SMART CHANGE

## **SARA**

General Manager

Metrics-focused leader. Nurturer of talent  
that carves out the competitive edge.







MY  
HUSH  
MY  
BUSINESS

General Manager



It's time we design our office spaces to abate sensory overload. Design must account for the fact that we're all battling distraction. It must encourage and protect focus, so we can all reach our potential. We simply can't afford to lose productivity to unthoughtful, inflexible design.

## HUSH

### OUR COMPETITIVE ADVANTAGE

#### Focus at a premium; employees are overwhelmed

Information-overload and excessive stimuli characterize our digital age. According to recent work from Deloitte Consulting, 65% of executives consider the 'overwhelmed employee' to be a serious, pervasive problem. Mastering the balance between device-time and face-to-face interaction can help, for one – human interaction slows down the pace of work while allowing one to re-connect with the purpose behind it.

#### The role of the office space

The office can also help. To abate sensory overload, spaces designated for deep concentration and solo work are critical. Enclosed group work pods are just as essential — so teams can meet in a space free of distraction. And all of these devoted working spaces should be complemented by lounges or areas to relax. The world is becoming ever-so-quick; people need opportunities to take breaks and re-center. The idea of providing this range of pods and spaces is to give employees total command over how they work and relax.



A functional office space is a prerequisite to innovation and long-term success.

#### TOP 5 SOURCES OF COMPETITIVE ADVANTAGE IN 2030\*

as rated by 70 experts and business leaders, 2014

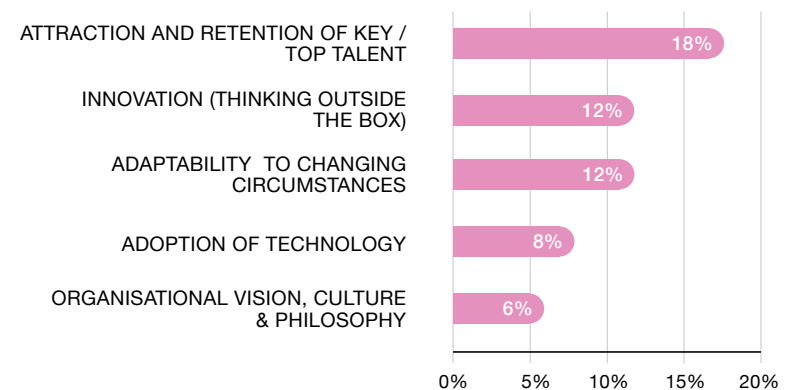

#### Companies can't afford to ignore 'employee overwhelm'

One thing is clear from CBRE Genesis's predictions: we can't afford to lose performance to poor design. We must protect our employees from overwhelm by designing smart spaces that foster flow. We must design for camaraderie, team building, relaxation, and other key needs employees consistently report. As managers, we are starting to shift our aim proactively in anticipation of an even-quicker future. A future where innovation and technology adoption make for winners. To win at both, we must first ensure the office space is holistically supporting basic employee needs.



## A SPACE FOR FREE THINKING

“ As we design for innovation more strategically, we must ask ourselves how well our environments support the creative process. One of the most lucrative steps in producing and developing new ideas is sharing the raw ones freely. Without the right environment, this tender process of idea-making is stunted.

**hushmeet.open.S**



A perfect place for sharing ideas

hushmeet.open.S

I MAKE THE  
OFFICE  
WORK FOR  
PEOPLE

## **BRAD**

Facility Manager

Analytical problem solver with an unparalleled drive to improve the office's functionality.



A man with short brown hair and a light beard is looking towards the camera. He is wearing a tan turtleneck sweater under a grey and white plaid blazer, and light grey trousers. He is holding a silver laptop in his right hand. The background is a modern office hallway with a grey wall and a sign with an upward arrow and the number '10'.

MY  
HUSH  
MY  
SUCCESS



# DRAWING TALENT BY GETTING THE ESSENTIALS RIGHT

and giving employees a variety of work environments

## According to employees, the ideal workplace masters the essentials

Cleanliness, comfort, noise level, temperature, lighting, air quality, and smell are the most crucial workplace factors, according to today's employees.\*

## And access to a variety of workspaces is critical

What are the most important factors for your workplace?

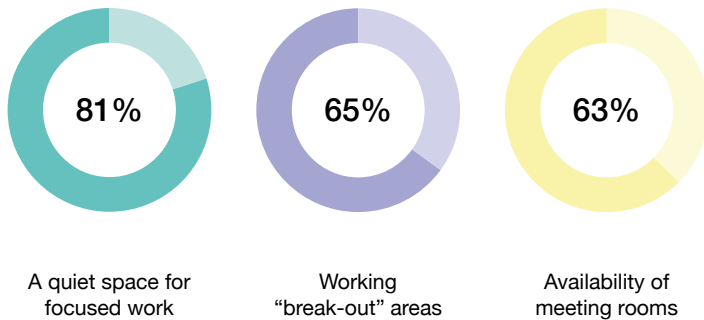

81% of workers regard having a quiet space for focused work as being highly important. And 63% feel the same way about meeting rooms while 65% feel the same way about breakout spaces. The takeaway: to satisfy employee needs, we must provide a range of environments within the office space. This range should include areas that support focused solo work, areas that support collaborative work, and areas that simply encourage relaxation and camaraderie among colleagues.



With the advent of the open office — and both its positive and negative effects — facilities management has become a crucial discipline to drive efficient business operations. And to pave the way for performance at new levels.

## The bad news: we're missing the mark on both

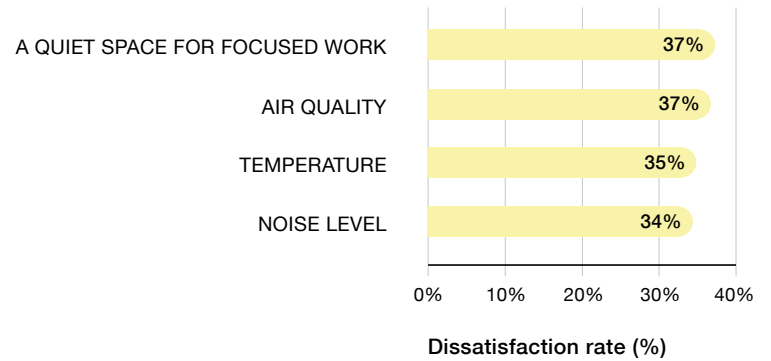

Workers are unsatisfied because they lack spaces for focused work. This 'lack' makes their number one complaint.

## And 30% of workers in open-plan offices feel that their workplace layout negatively impacts their productivity.

Only 11% in private offices feel this way. Without a private working space, focus, comfort, well-being, and all related factors that feed performance suffer.

Workers are also unsatisfied with their environment across the board. The air quality, temperature, and noise level represent their number two complaint. The problem is that, in the open office, individuals have no control over these factors; they are simply subject to the building's settings and natural flows. These top two complaints highlight a concerning fact: we're missing the mark on the essentials, and, simultaneously, failing to provide an essential need: a quiet space to work.

\*Savill's (2019) , What workers want: Europe, p.4

# HUSH

## A NEW APPROACH TO OPTIMIZING THE LAYOUT

hushmeet

“ Hush represents the smart strategy for keeping up with changing needs.

### FINE-TUNE YOUR OFFICE SPACE — CONTINUALLY

Hush pods are mobile and modular – they can be easily expanded, adapting to team, client, or project needs in real-time. You can implement them one at a time to test their success; they are a supreme alternative to expensive, time-consuming infrastructure. As work dynamics evolve and teams shift, Hush keeps up, continually supporting your needs. They also allow you to be more independent from your landlord as you fine-tune your office space.



#### **Mobility**

more info on pages 86-87

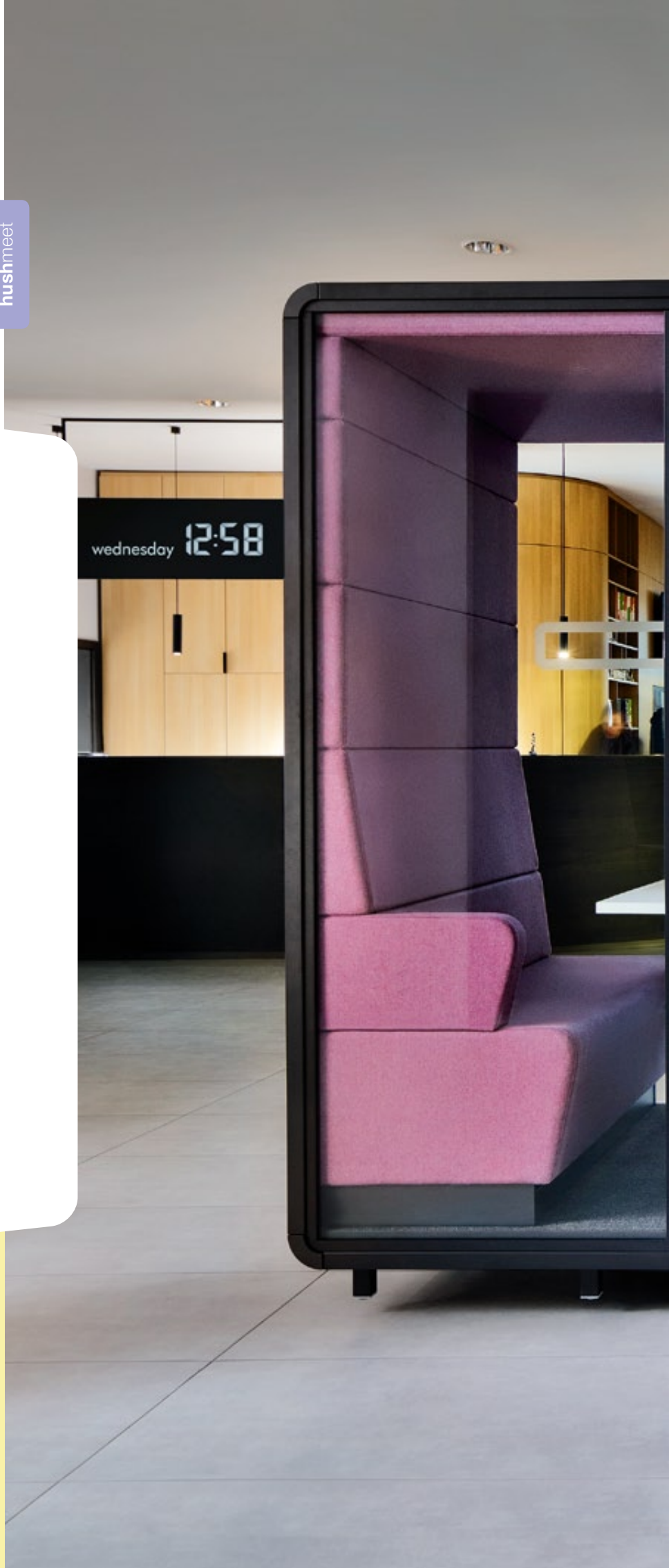



# MAKING A CASE FOR HUSH



## FINANCIAL DIRECTOR

### Outlining the economic and space-optimization benefits of Hush

- no permanent infrastructure
- one-time investment – an asset
- space optimization; pods are compact, with solo units taking up less space than a desk
- less-stress office relocations; pods are easy to disassemble and relocate
- no more expensive fit-out projects when moving into a new space – set up a fully-functional, modern office quickly with Hush

## GENERAL MANAGER

### Outlining Hush as the adaptive solution

- modular, mobile, and easy-to-relocate; a smart strategy for keeping up with changing workplace needs
- rearrangeable within the day to meet team, client, or projects needs swiftly
- no permanent infrastructure required; smoother negotiations with landlords, easier move in and office setup

## ARCHITECT

### Outlining how Hush completes a space's aesthetic as it provides sheer utility

- modern, sleek aesthetic
- customizable interior and exterior color and frame to match a client's branding
- quick, easy layout changes; pods are easy to relocate and expand
- respond to changing workplace needs quickly; send out a survey, gauge the gap, and close it by expanding, moving, or purchasing pods



Bringing your team on board with implementing Hush pods in your workplace

## HR MANAGER

### Outlining Hush as the dynamic way to support performance

- give employees authority over their work environment – a contributor to job performance
- transform the office plan easily because pods are modular, mobile, and independent
- eliminate the open office's 'noise' problem; pods are soundproofed both ways

## EMPLOYEES

### Outlining how Hush helps you find peak performance and well-being

- focus, collaborate, or relax; each pod model supports a specific kind of task
- fine-tune your environment by adjusting music, lighting, and ventilation in each pod
- pods give you privacy, comfort, and ownership over your space
- energize your workflow – switch pods to switch gears for each task



# I DESIGN EVOLVING OFFICES

## ZACHARY

Architect

Part engineer, part artist. Builder of workspaces that serve utility, beauty, and health.







THE OFFICE SPACE  
MUST CREATE  
**VARIETY, CHOICE,  
AND AUTONOMY**

Gensler’s U.S. Workplace Survey 2019 reports workplaces that offer variety and encourage mobility throughout the day boast higher-performing employees. As companies recognize this link, office design will be called on more directly to provide that variety, choice, and autonomy.



**Team building is the most important aspect of a great workplace**

Gensler’s survey also found that employees regard team building as the single most important aspect of a great workplace. As designers and builders, we must be sure to invest in the right working spaces that effectively build teams.\*

Percent of respondents who selected each attribute as describing the “best” workplaces.



“ Environments that are mostly open environments but provide ample on-demand private space have both the highest effectiveness and the highest experience scores.

**The solution: build an office that adapts**

The workforce is going more remote, and work functions continue to evolve, getting more complex. What’s more, team hierarchies tend to shift at each quarter, altering team dynamics. Change is the norm. And the office space needs to adapt to this change. The key is designing a space that can respond to fluctuations with minimal capital expense. A space that provides that variety, choice, and autonomy.

\*Gensler (2019), U.S. Workplace survey, p.10-11

# PARTICIPATORY **SPACE PLANNING**

Because Hush pods make layout changes easy, employees can play a more active role in the design of their office.

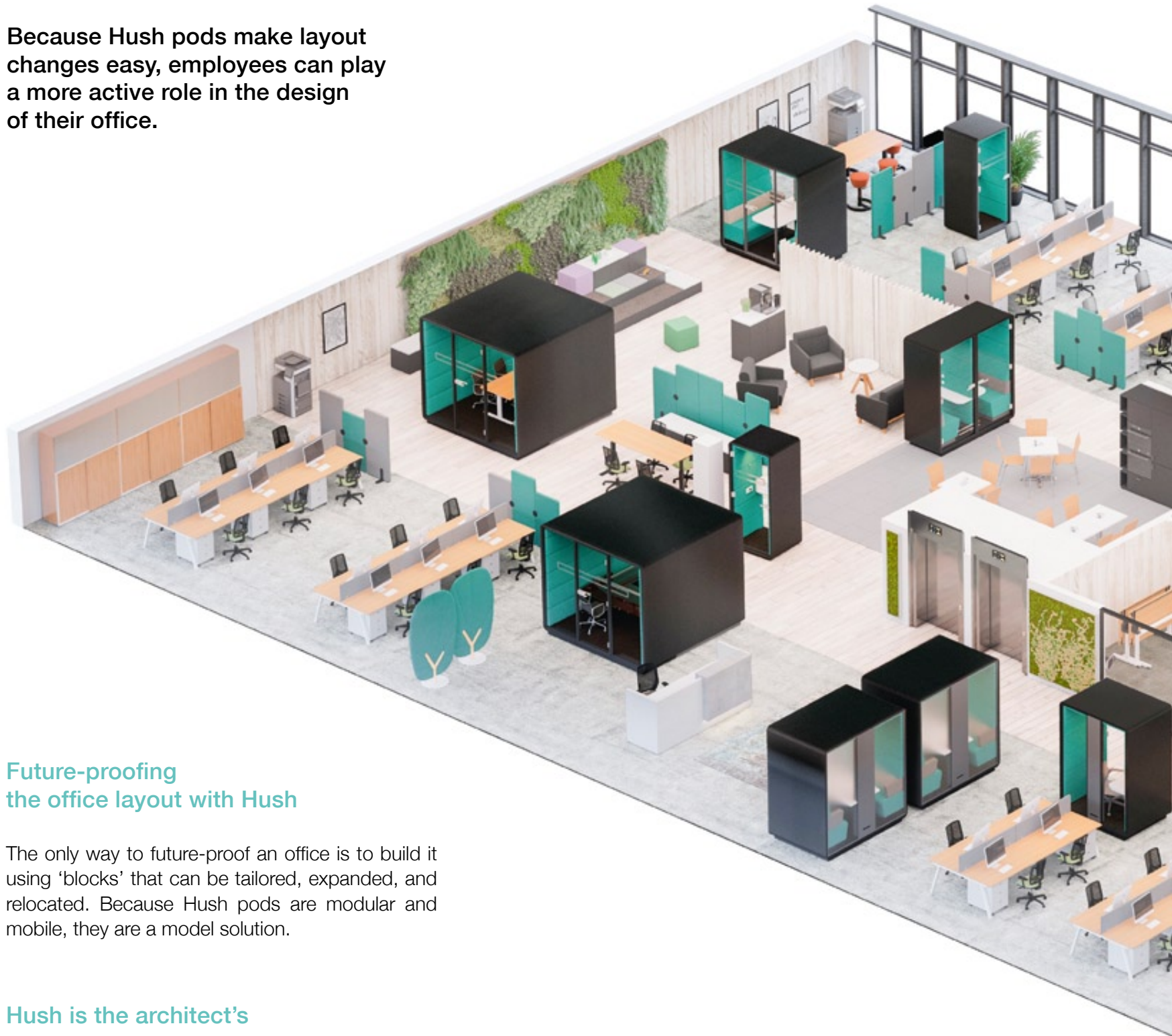

## Future-proofing the office layout with Hush

The only way to future-proof an office is to build it using 'blocks' that can be tailored, expanded, and relocated. Because Hush pods are modular and mobile, they are a model solution.

## Hush is the architect's tool to achieve the shared vision

Hush doesn't take the place of an architect's creative skill but instead leverages this skill toward a smarter aim: build for the future. The architect still plays the leading role in designing layouts and fine-tuning them over time — only each layout tweak is easy because Hush is like a building block.

## Empowered employees

Because Hush pods are like building blocks, they allow employees to be actively involved in the design of their space. Teams can issue new requests, work with the architect to problem-solve a better layout, and see changes within a week.

## DESIGNING WITH HUSH: THE GOLDEN RULES

- Place hushPhone in proximity to workstations. Each employee should be able to walk to the pod from their desk before the fourth ring.
- Place hushWork and hushMeet in proximity to workstations. For additional privacy and comfort, frost the rear glass panels.
- HushMeet.L is a large pod — it works well as a conference room, temporary manager's office, or private work room for small teams.
- Because hushMeet and hushWork are compact, they don't block the flow of communication across benching workstations.
- 2 desks can be replaced by 1 hushMeet/hushWork without losing the additional office space

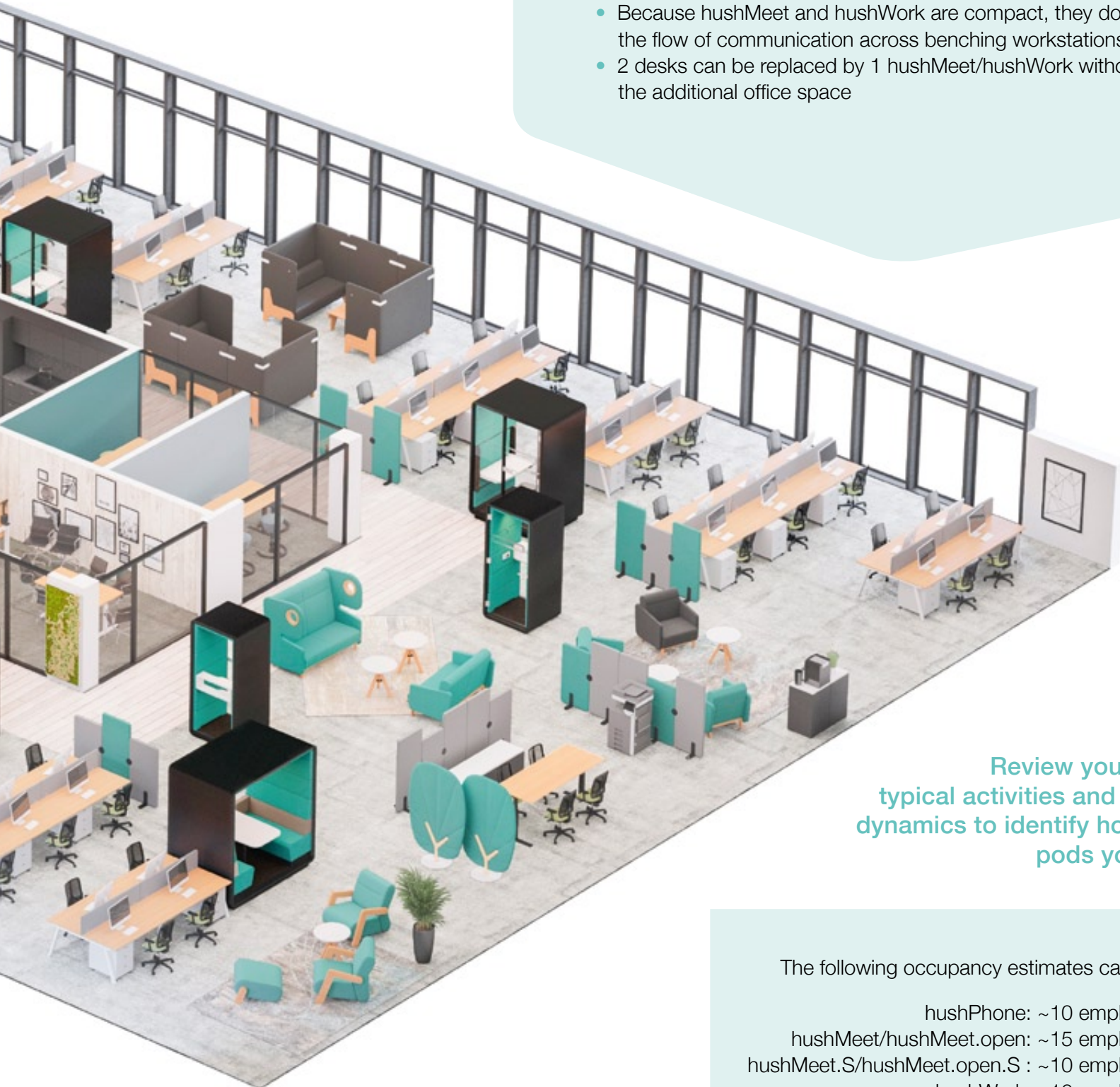

Review your team's typical activities and working dynamics to identify how many pods you need.

The following occupancy estimates can help:

hushPhone: ~10 employees;  
 hushMeet/hushMeet.open: ~15 employees;  
 hushMeet.S/hushMeet.open.S : ~10 employees;  
 hushWork: ~10 employees;  
 hushMeet.L: ~40 employees

# ADAPTABLE BY DESIGN

hushmeet.L

## hushmeet.L



A perfect place for private meetings

HushMeet.L is made by conjoined modules. A team can simply add or remove these modules to expand or scale down the pod and modify their layout without creating any waste, disruption, or cost — all within one workday. Because hushMeet.L is built for change, it adapts by design.



**Facilities**  
more info on page 112





“ With access to a range of work environments, employees are empowered to master the balance between work and play. And play is a necessary part of work — mastering this balance improves output.



**hush**meet.L









## ACOUSTICS AND WELL-BEING

### WELL-DESIGNED ACOUSTICS ARE PART AND PARCEL OF EMPLOYEE HEALTH

Sound is a central aspect of our lives. We hear it even when we're sleeping. Too much of it, and we're stressed out and distracted, unable to find flow. But not enough of it and we feel uncomfortable. Work pods hit the sweet spot, delivering the optimal acoustic level for work and well-being.



#### Acoustics

more info on pages 88-91

# IMPROVING AIR QUALITY; IMPROVING WORKPLACE EXPERIENCE



Bring nature within reach!



hush  
twin

hush  
twin



## Plants are nature's air purifiers.

They are a visceral reminder of mother nature's generosity. With each inhale, they filter out pollutants. With each exhale, they give us the oxygen we need to live and thrive. Just imagine a thick green wall of plants in your open space. How does the visual make you feel?

Our fully equipped 'green wall' system allows you to cover the exterior panels on each Hush pod with plants. The system comes with a frame, integrated flower pots, and electronic irrigation. The lushness of its growth taps into the benefits of biophilia. It's the beautiful, easy, and obvious way to bring nature within reach.

**hushmeet.L**



# EXPAND YOUR POD; **GROW** **YOUR GREEN** **WALL**

## **hushmeet.L**

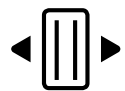

A meeting space that adapts to change

HushMeet.L is a pod built by modules. Expand it by adding new modules to accommodate between 4 and 8 people. The product is a smart alternative to permanent conference rooms that are outdated within a few quarters. Best of all, as you grow your pod, you can grow its outward-facing green wall.



### **Modular**

more info on pages 106-107



**hushmeet.L**



# I INVEST IN SMART SOLUTIONS

## **KEVIN**

Landlord

Office real estate manager passionate  
to sustain the workplace of the future.







## MY HUSH MY ADVANTAGE

### TENANTS WANT **FLEXIBLE OFFICE BUILDINGS**

According to CBRE Genesis's Fast Forward 2030 report, tenants are more confident signing longer leases when the space is flexible. This is because there is a serious need, across industries, to be able to modify and adapt the office space easily, creating and re-creating its variety of working spaces. Because our era is defined by 'change.' So our office building must be flexible in responding to this change.

“ As landlords, we have the opportunity to positively influence an organization's bottom line — by helping them achieve the flexibility we all need in an agile world. I see this opportunity as a privilege.

“ For the past five years, I've been sharpening my edge to win more long-term tenants. Amenities have been a major help here because, increasingly, teams want move-in-ready, modern spaces that can adapt to their change. And smart amenities, like work pods, afford this adaptability. They are also quick to install and modern looking.

### **Employees want unconventional working spaces**

Above all else, employees want choice in when, where, and how they work. Companies have addressed this 'want' by balancing traditional desk space with spaces that give employees this 'choice': breakout spaces, lounges, and work pods, for example. The big benefit here: each environment is uniquely equipped to support a specialized task. So a range of such environments allows employees to master tasks in the right environment. A strong performance gain follows.

### **Provide the right amenities; move in long-term tenants quickly and easily**

Flexibility is attractive to long-term tenants. And, in the office, flexibility breaks down into amenities. Teams want perks like work pods that give them choice in how they work and more control over their space. The great benefit to a solution like the work pod is that many are modular — they can be expanded or scaled down as tenant's needs fluctuate. They are mobile, making the office layout adaptable and easy to change. Such a solution replaces permanent structures, which reduces a landlord's build-out and fit-out responsibilities. This is where flexibility and amenities can be one.



## KEEP TENANTS SATISFIED

“ Because Hush work pods are modular and mobile, they make big office layout changes easy. This ease is dynamite; I can keep my tenants satisfied through time with no extra capital expense.

### MEETING AND WORKING SPACES THAT RESPOND TO CHANGE AT PACE WITH THEM

Flexibility is at the heart of the work pod's design. Each pod is mobile or modular, responding to changes readily. Tenants need this flexibility because they know change is inevitable — a flexible space made up of flexible pods is keen to this. The ability to easily alter the layout keeps tenants satisfied for the long haul.



# HUSH LINE PRODUCTS





Each Hush pod is distinct in size and design, supporting a specific work task, pattern, or need. But they all provide two things: finely engineered soundproofing and mobility. You can also customize colors and specify the exact accessories you need. To learn more about the options for both join us as we deep dive into every technical feature that makes Hush the solution.

# HUSH IS AGILE BY EVERY MEASURE

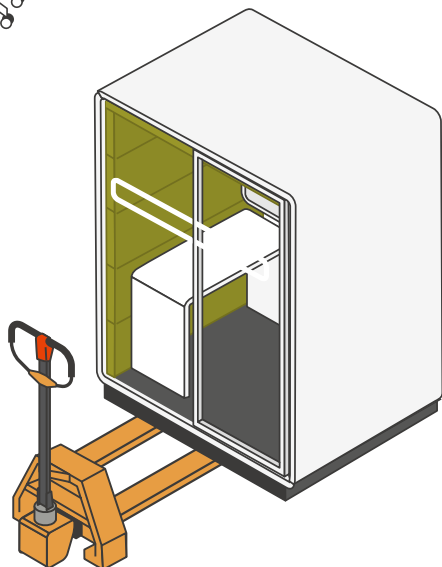

## MOBILE AGILITY; EASY LAYOUT CHANGES



None of the core Hush pods require disassembly for relocation. HushPhone has built-in castors that allow employees to move it with a simple push. All other pods sit on a frame that creates about 10 cm of space beneath for a pallet jack to lift. Rearrangement takes a few minutes and creates no mess or interruption of employees.

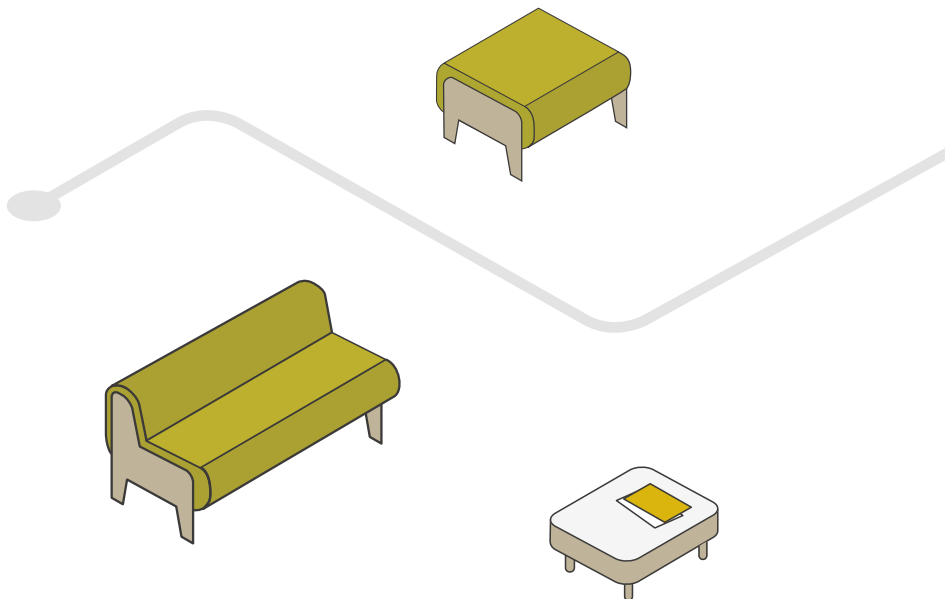

Integrated castors and leveling feet on hushPhone



Space beneath all other Hush pods for a pallet jack

## RELOCATION AGILITY; STRESS-FREE OFFICE MOVES

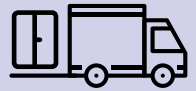

Unlike the traditional conference room, Hush comes with you when you move. Think of Hush as you think of any other company asset; it's a piece of equipment you keep forever. Best of all, it adapts to change.

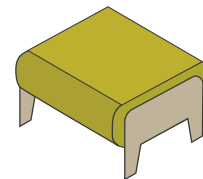
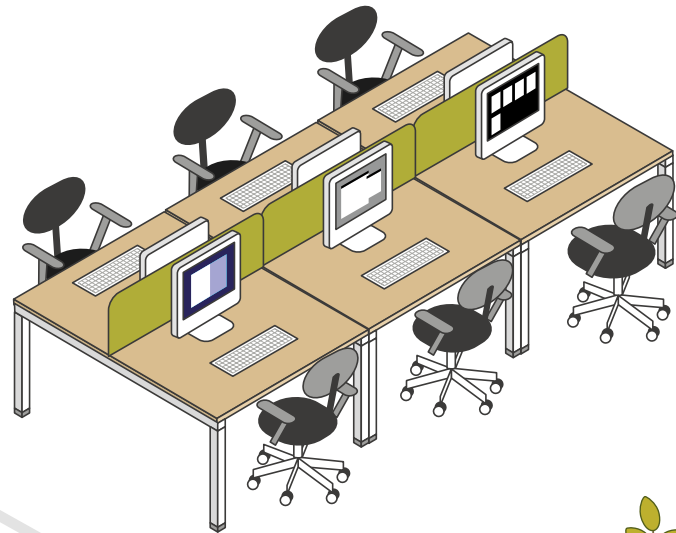
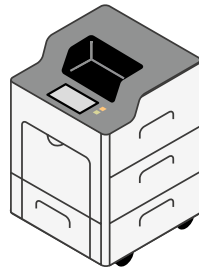
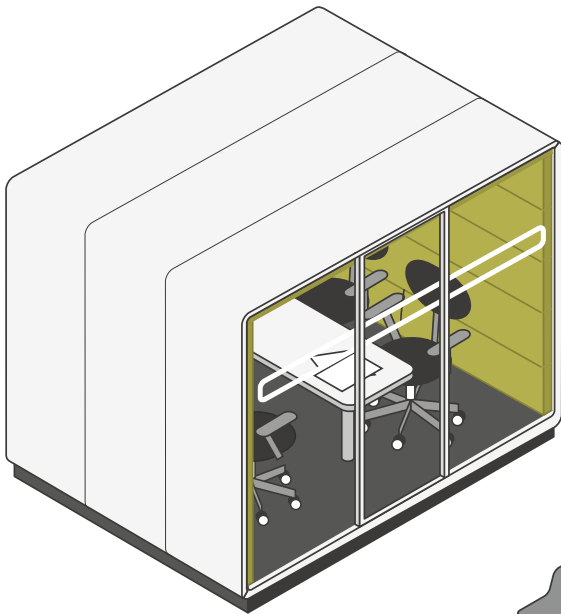

## THE RIGHT CHOICE FOR THE ENVIRONMENT



With Hush, when your team needs layout changes, you don't have to demolish and build new infrastructure to make them. You can simply rearrange your pods and expand or size down the modular ones as suitable. For this, Hush's life cycle is tenfold that of a conference room. And at the end of their long life, the majority of their materials can be recycled.

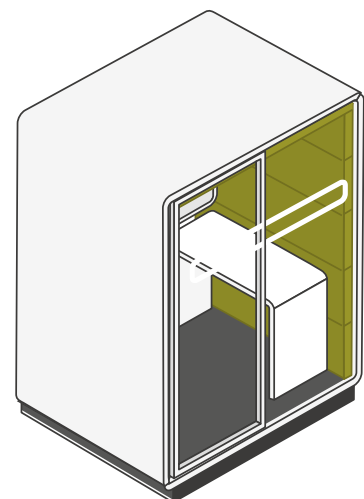

---

# ACOUSTIC INSULATION OF THE HUMAN VOICE IS OUR SPECIALTY.

WE AIM TO BE THE  
BEST IN OUR FIELD



## TEST. IMPROVE. REPEAT.

We test our products with cutting edge technologies in professional environments. Our team is committed to bringing the best possible solutions to the market.





## HUSH ACOUSTICS – SILENCE DONE RIGHT

Our goal is not absolute silence because total silence is unnatural and unhealthy. Instead, Hush provides an ideal acoustic environment for users, as it contains their noise, so colleagues outside aren't disrupted either.



### UNHEALTHY SILENCE

Total silence isn't the goal; we are evolutionarily adapted to sound. We hear it even when we dream – it is a central aspect of our lives.



### QUIET OFFICE

The sound that's made in Hush stays in Hush. Because of this, each pod makes the office quieter.



### SAFETY ISSUES

A user can hear the office's fire alarm from inside their Hush, even when they are talking loudly on the phone.

# IDEAL ACOUSTICS THROUGH THE FINER DETAILS



## Noise insulation solutions

Sound is like water. It wants to flow. Hush pods are built to absorb, block, and cover this flow, preventing it from seeping in an undesirable way. How? Through the finer details.



1

### ACOUSTIC LINED FABRIC PANELS

A variety of materials make Hush's interior walls. These materials provide complementing acoustic properties.

2

### ACOUSTIC GLASS

Thick, 10mm laminated glass achieves excellent sound insulation.

3

### ACOUSTIC GASKETS

A high-quality and finely-engineered system of gaskets completes Hush's soundproofing.

# WHAT IS HUSH LIKE IN REAL LIFE?

Acoustics is a difficult topic to understand. To make it easier, let's use examples.

ABOUT 8  
TIMES MORE  
QUIET INSIDE  
THE HUSH

Open office noise is the volume of a blaring TV (~70 dB). HushPhone takes this noise and converts it into 36 dB: a decibel level as peaceful as the sound of singing birds.

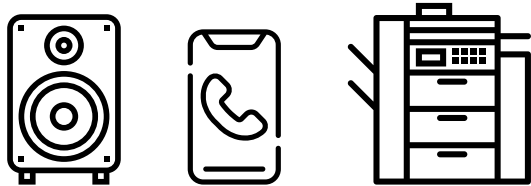

70 dB



36 dB

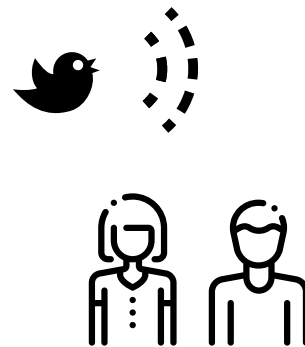

Inside Hush, every conversation is converted to the volume of a whisper, and can barely be heard from outside.

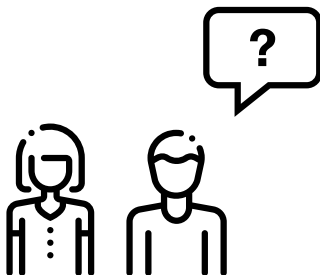

26 dB

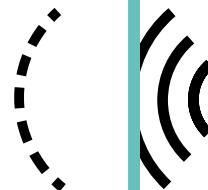

60 dB

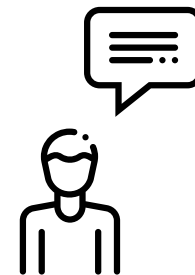



**INDIVIDUAL WORK**

**TEAMWORK**

**hushphone**

**hushwork.sit&stand**

**hushwork**

**hush twin**

**hushmeet.S**



  
Up to  
one person

  
Up to  
one person

  
Up to  
one person

  
Up to  
two people

  
Up to  
two people

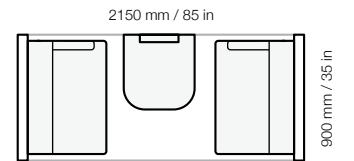
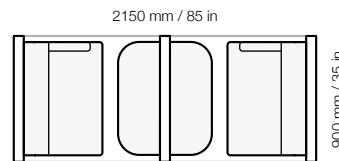
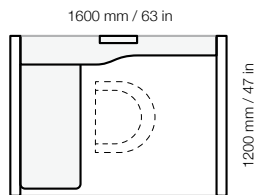
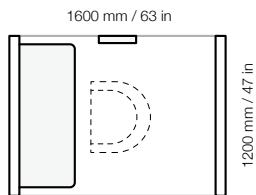
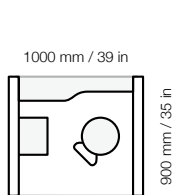

RELAX

**hushmeet**



Up to four people

**hushmeet.L**



Up to eight people

**hushmeet.open.S**



Up to two people

**hushmeet.open**



Up to four people

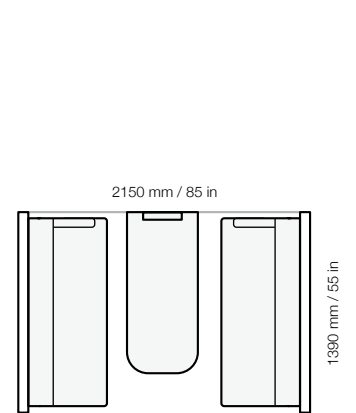
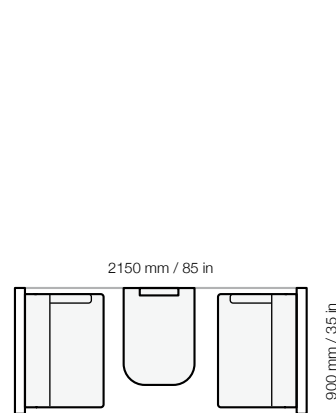
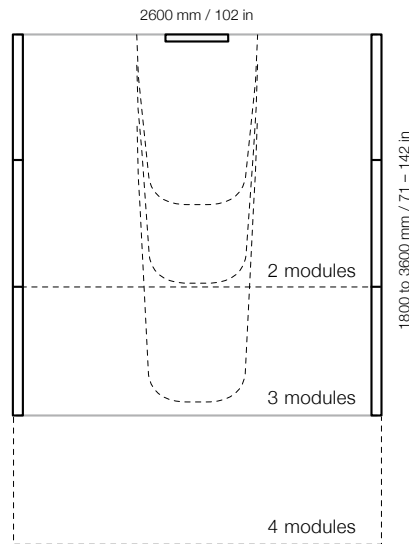
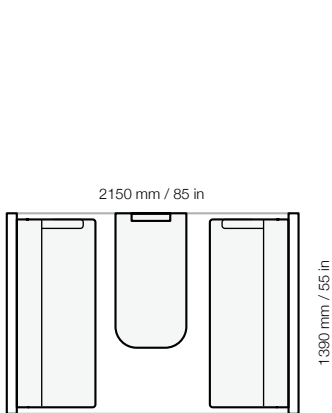

# HUSHPHONE

## TECHNICAL FEATURES

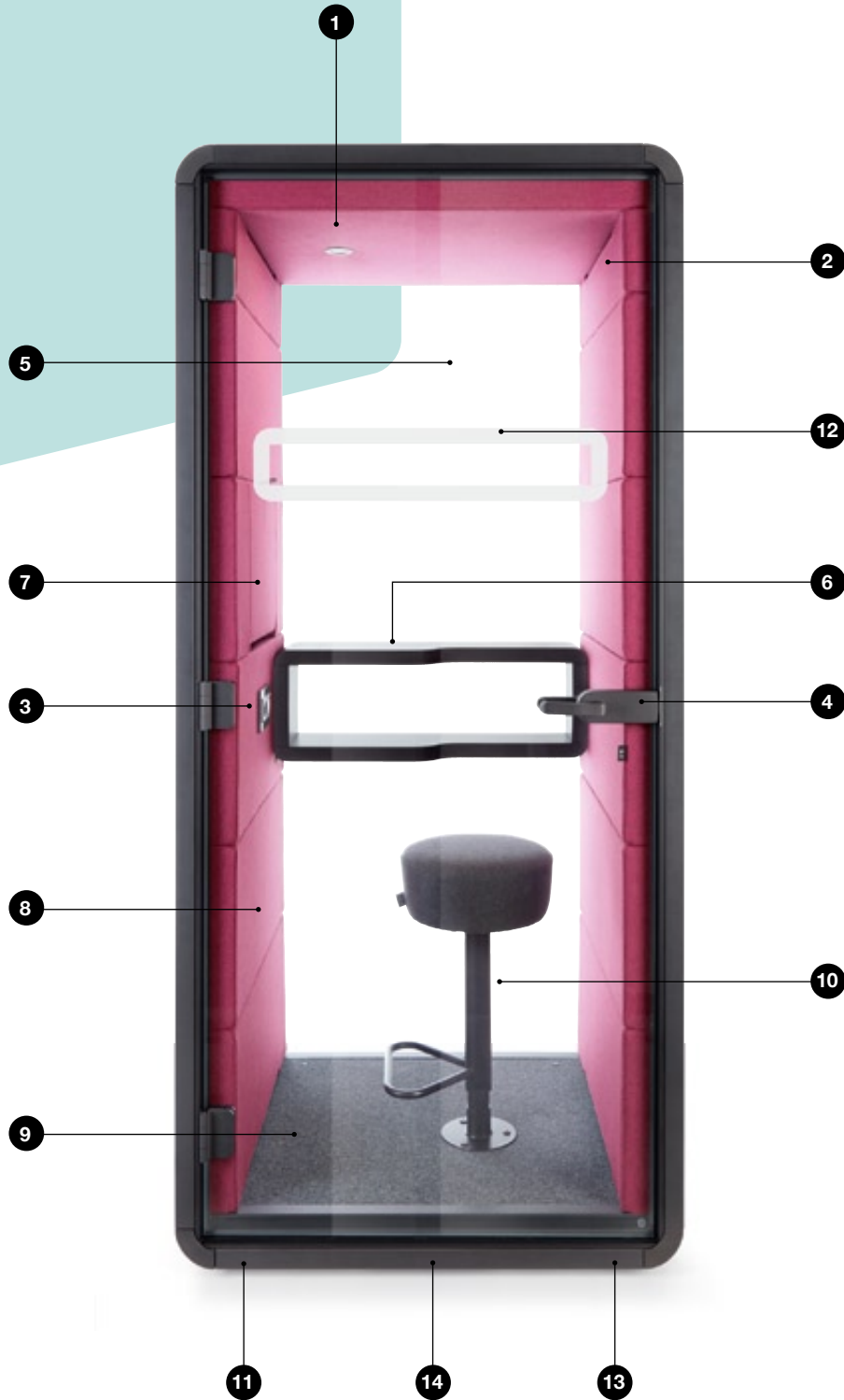



**WIDTH**  
1000 mm / 39 in

**HEIGHT**  
2230 mm / 88 in

**DEPTH**  
900 mm / 35 in

**WEIGHT**  
320 kg / 705 lbs



Up to  
one person



- |  |  |   |
|--|--|---|
| <p><b>1</b> Led ceiling light run by motion sensor</p>                           | <p><b>5</b> Laminated acoustic glass rear wall</p> | <p><b>10</b> Optional floor mounted stool</p>       |
| <p><b>2</b> Efficient ventilation run by motion sensor</p>                       | <p><b>6</b> Ergonomic shelf / storage</p>          | <p><b>11</b> Leveling feet</p>                      |
| <p><b>3</b> Power module (single power, double USB)</p>                          | <p><b>7</b> Fold-away laptop table</p>             | <p><b>12</b> Anti-collision door marking</p>        |
| <p><b>4</b> Tempered, laminated acoustic glass door with high quality handle</p> | <p><b>8</b> Acoustic lined fabric panels</p>       | <p><b>13</b> Integrated Castors</p>                 |
|  | <p><b>9</b> Integral carpeted floor</p>            | <p><b>14</b> Optional – seismic floor provision</p> |

# HUSHWORK.SIT&STAND

## TECHNICAL FEATURES



**hush**work.sit&stand

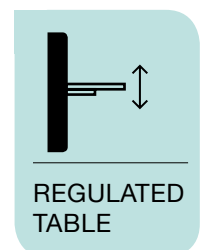





**WIDTH**  
1600 mm / 63 in

**HEIGHT**  
2300 mm / 91 in

**DEPTH**  
1200 mm / 47 in

**WEIGHT**  
535 kg / 1179 lbs

  
Up to  
one person



- 1 Led ceiling light with dimmer
- 2 Optional – grommet in ceiling for sprinkler provision
- 3 Ventilation system activated by a presence sensor
- 4 Option to add Bluetooth speaker
- 5 Laminated front and back acoustic glass panels

- 6 Anti-collision door marking
- 7 Tempered, laminated acoustic glass door with high quality handle
- 8 Desk with manual adjustment height – range 670-1250 mm / 26-49 in
- 9 Independent, manual smooth lighting and ventilation rotary knobs

- 10 Power module (Power + USB + RJ45)
- 11 Leveling feet
- 12 Removable front panel for pallet jack
- 13 Optional – seismic floor provision

# HUSHWORK

## TECHNICAL FEATURES

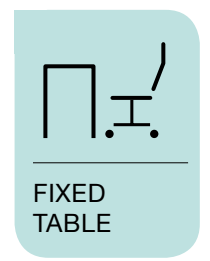



**WIDTH**  
1600 mm / 63 in

**HEIGHT**  
2300 mm / 91 in

**DEPTH**  
1200 mm / 47 in

**WEIGHT**  
490 kg / 1080 lbs



Up to  
one person



- 1 Led ceiling light with dimmer
- 2 Optional – grommet in ceiling for sprinkler provision
- 3 Ventilation system activated by a presence sensor
- 4 Option to add Bluetooth speaker
- 5 Anti-collision door marking

- 6 Laminated front and back acoustic glass panels
- 7 Tempered, laminated acoustic glass door with high quality handle
- 8 Classic desk, without the height adjustment
- 9 Ergonomic shelf / storage

- 10 Independent, manual smooth lighting and ventilation rotary knobs
- 11 Power module (Power + USB + RJ45)
- 12 Leveling feet
- 13 Removable front panel for pallet jack
- 14 Optional – seismic floor provision

# HUSHTWIN

## TECHNICAL FEATURES

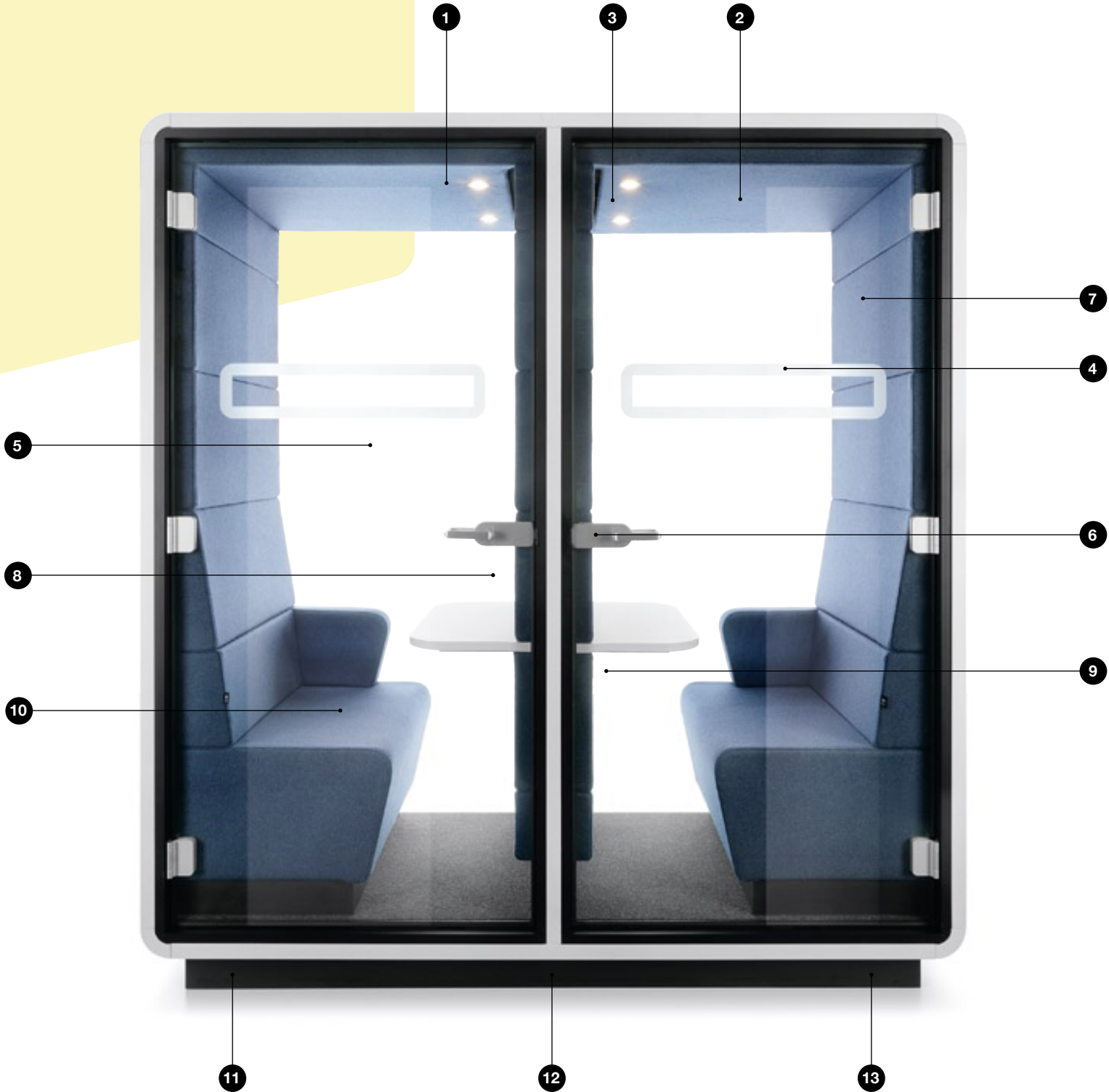



**WIDTH**  
2150 mm / 85 in

**HEIGHT**  
2300 mm / 91 in

**DEPTH**  
900 mm / 35 in

**WEIGHT**  
580 kg / 1279 lbs



Up to  
two people



- 1 Led ceiling light with dimmer
- 2 Optional – grommet in ceiling for sprinkler provision
- 3 Ventilation system activated by a presence sensor
- 4 Anti-collision door marking
- 5 Laminated acoustic glass rear wall

- 6 Tempered, laminated acoustic glass door with high quality handle
- 7 Acoustic lined fabric panels
- 8 Independent, manual smooth lighting and ventilation rotary knobs
- 9 Power module (Power + USB + RJ45)

- 10 Two upholstered benches
- 11 Leveling feet
- 12 Removable front panel for pallet jack
- 13 Optional – seismic floor provision

# HUSHMEET.S

TECHNICAL  
FEATURES

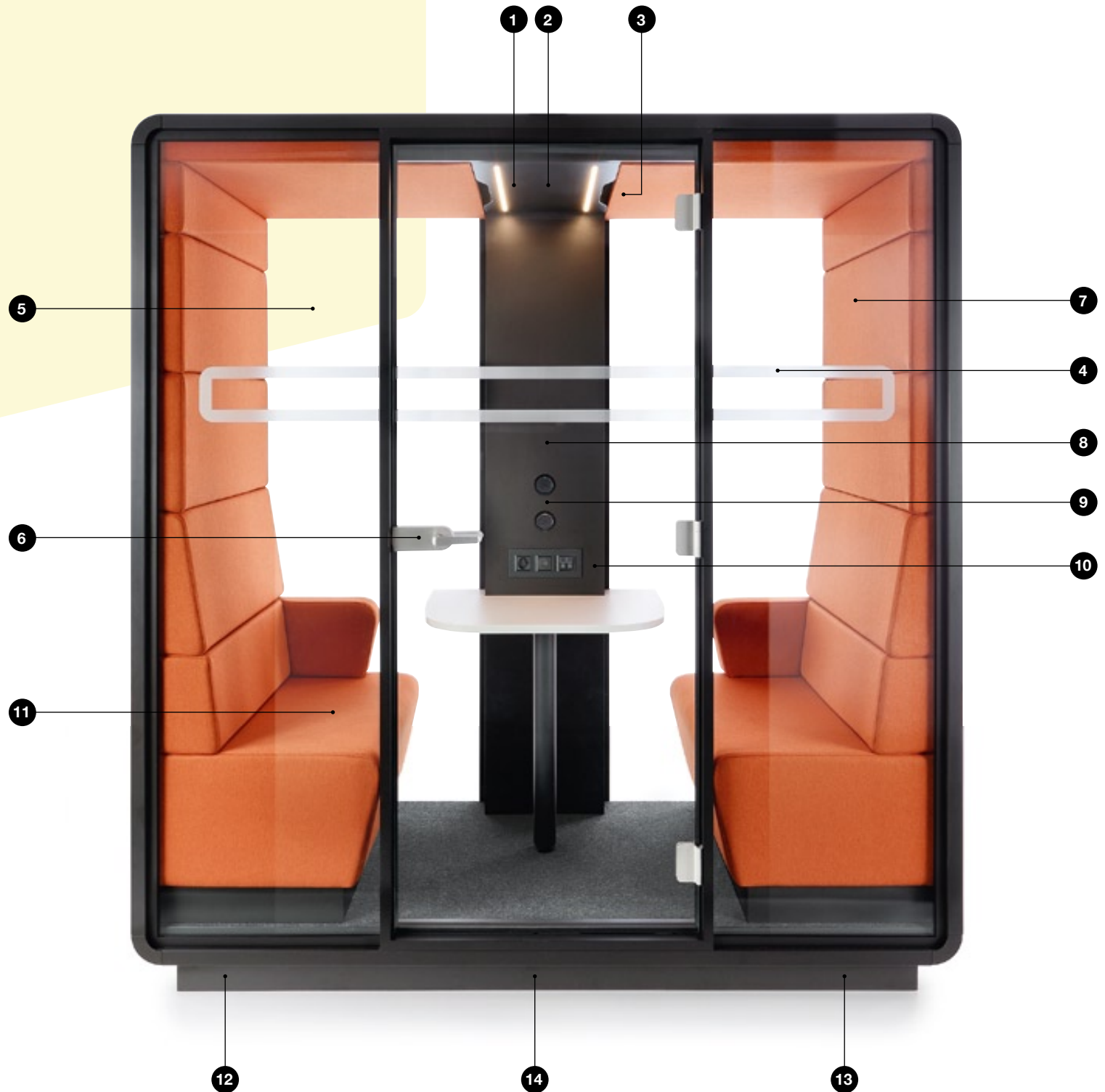
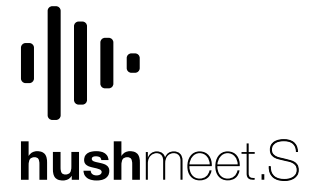



**WIDTH**  
2150 mm / 85 in

**HEIGHT**  
2300 mm / 91 in

**DEPTH**  
900 mm / 35 in

**WEIGHT**  
530 kg / 1168 lbs



Up to  
two people

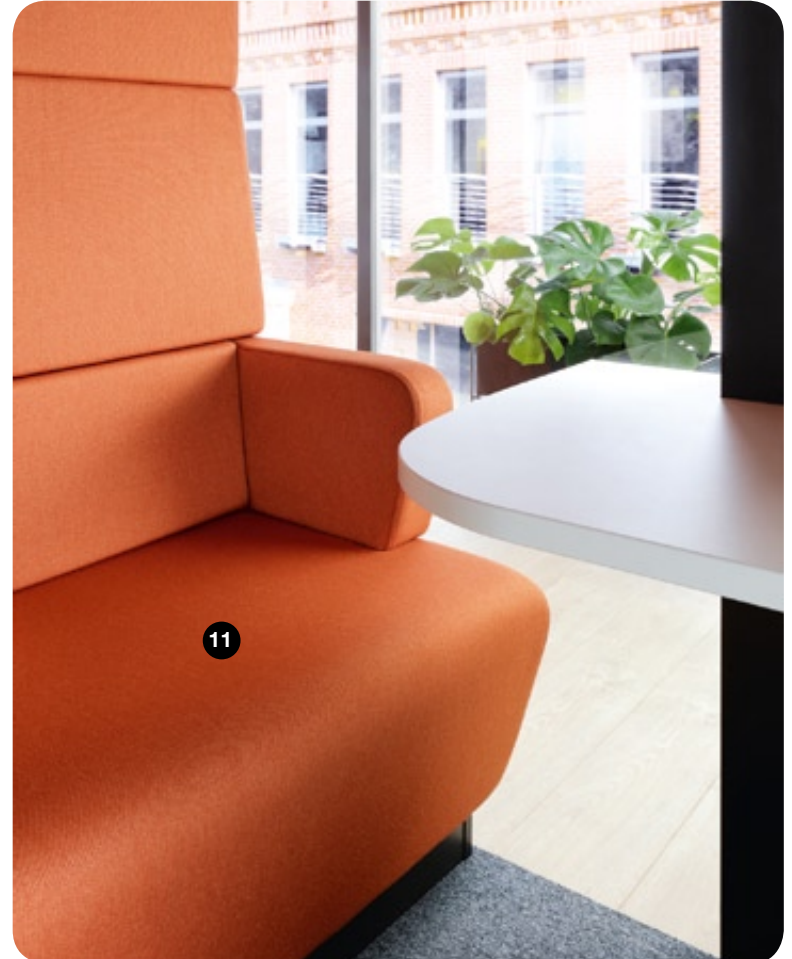

- 1 Led ceiling light with dimmer
- 2 Optional – grommet in ceiling for sprinkler provision
- 3 Ventilation system activated by a presence sensor
- 4 Anti-collision door marking
- 5 Laminated front and back acoustic glass panels

- 6 Tempered, laminated acoustic glass door with high quality handle
- 7 Acoustic lined fabric panels
- 8 Option to hang a TV screen on the central panel
- 9 Independent, manual smooth lighting and ventilation rotary knobs

- 10 Power module (Power + USB + RJ45)
- 11 Two upholstered benches
- 12 Leveling feet
- 13 Removable front panel for pallet jack
- 14 Optional – seismic floor provision

**HUSHMEET**  
TECHNICAL  
FEATURES

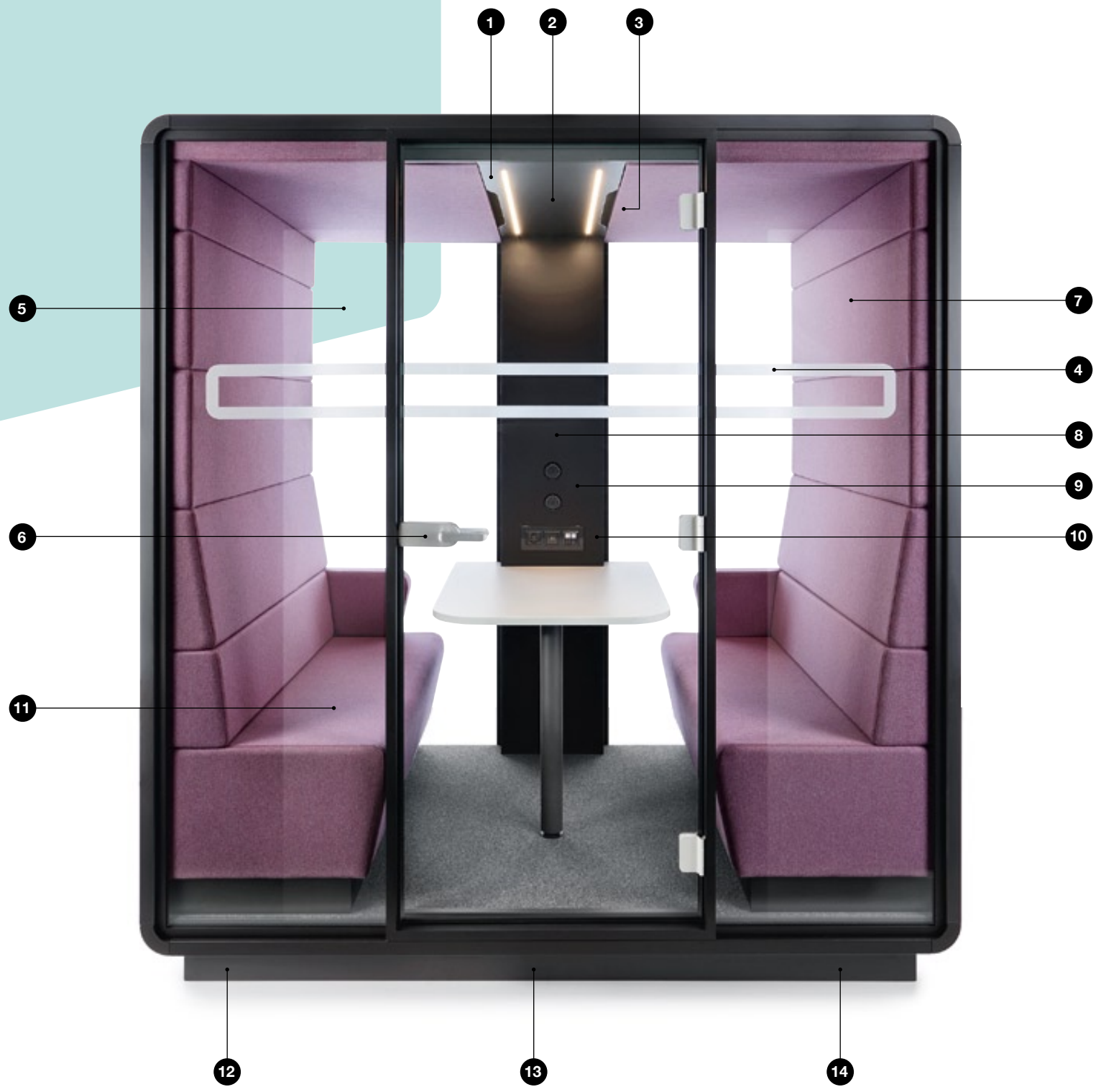





**WIDTH**  
2150 mm / 85 in

**HEIGHT**  
2300 mm / 91 in

**DEPTH**  
1390 mm / 55 in

**WEIGHT**  
650 kg / 1433 lbs



Up to  
four people



- 1 Led ceiling light with dimmer
- 2 Optional – grommet in ceiling for sprinkler provision
- 3 Ventilation system activated by a presence sensor
- 4 Anti-collision door marking
- 5 Laminated front and back acoustic glass panels

- 6 Tempered, laminated acoustic glass door with high quality handle
- 7 Acoustic lined fabric panels
- 8 Option to hang a TV screen on the central panel
- 9 Independent, manual smooth lighting and ventilation rotary knobs

- 10 Power module (Power + USB + RJ45)
- 11 Two upholstered benches
- 12 Leveling feet
- 13 Removable front panel for pallet jack
- 14 Optional – seismic floor provision

# HUSHMEET.L

## TECHNICAL FEATURES

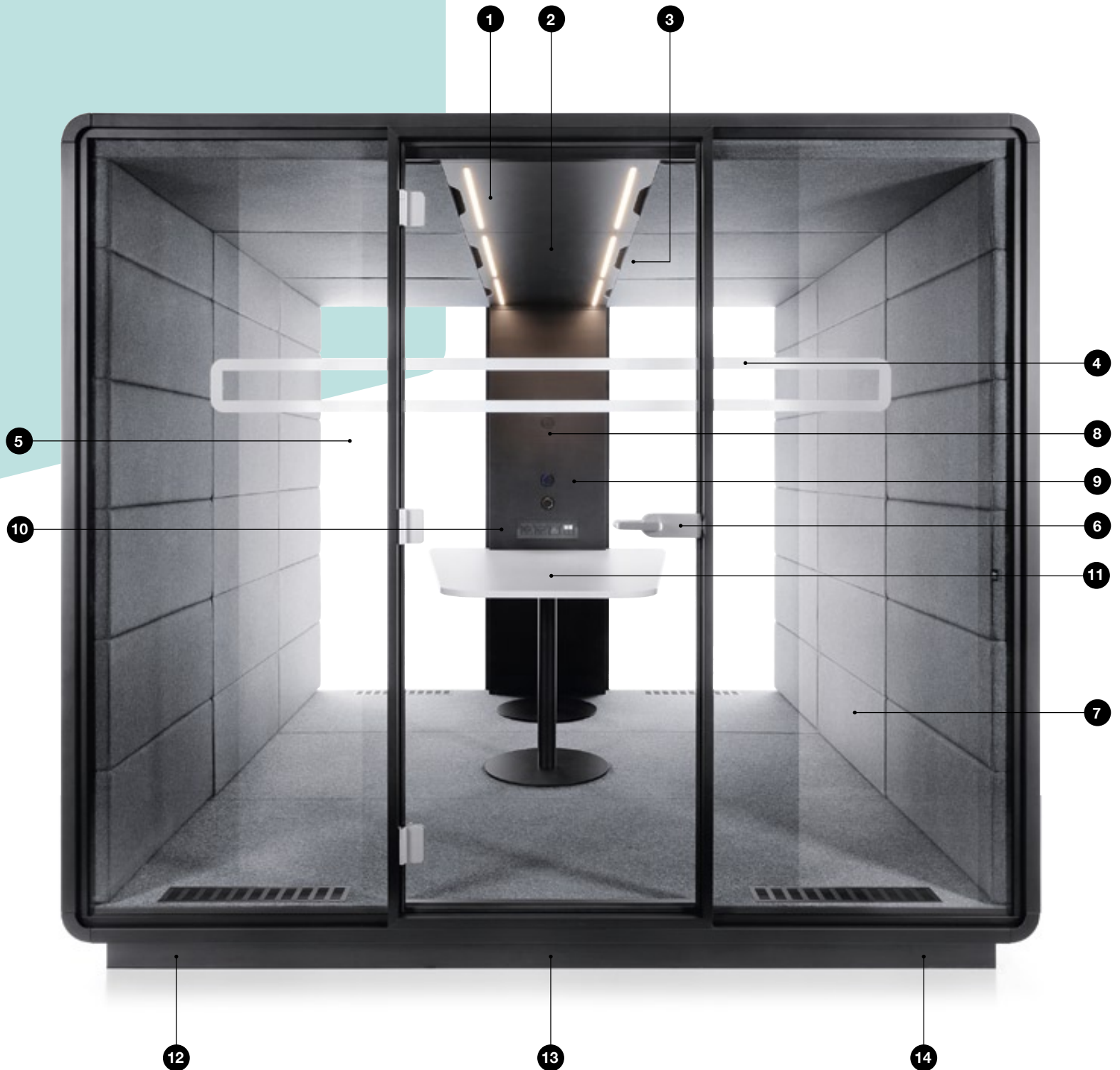
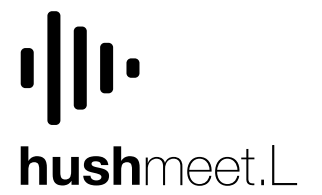



**WIDTH**  
2600 mm / 102 in

**DEPTH**  
1800 - 3600 mm / 71-142 in

**HEIGHT**  
2300 mm / 90 in

**WEIGHT**  
775-1475 kg / 1708 - 3251 lbs

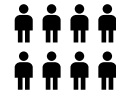

Up to  
eight people

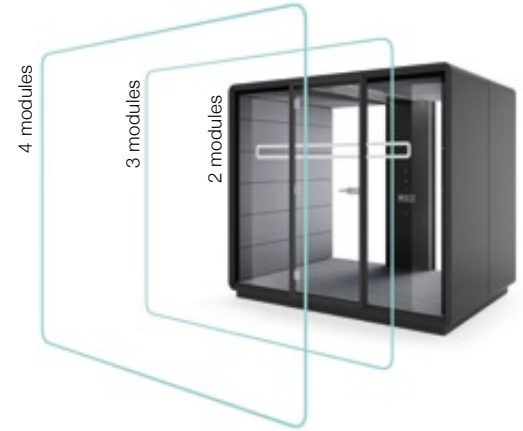

- 1 Led ceiling light with dimmer
- 2 Optional – grommet in ceiling for sprinkler provision
- 3 Ventilation system activated by a presence sensor
- 4 Anti-collision door marking
- 5 Laminated front and back acoustic glass panels

- 6 Tempered, laminated acoustic glass door with high quality handle
- 7 Acoustic lined fabric panels
- 8 Option to hang a TV screen on the central panel
- 9 Independent, manual smooth lighting and ventilation rotary knobs

- 10 Power module (Power + USB + RJ45)
- 11 Optional – conference table
- 12 Leveling feet
- 13 Removable front panel for pallet jack
- 14 Optional – seismic floor provision

# HUSHMEET.OPEN.S

TECHNICAL  
FEATURES

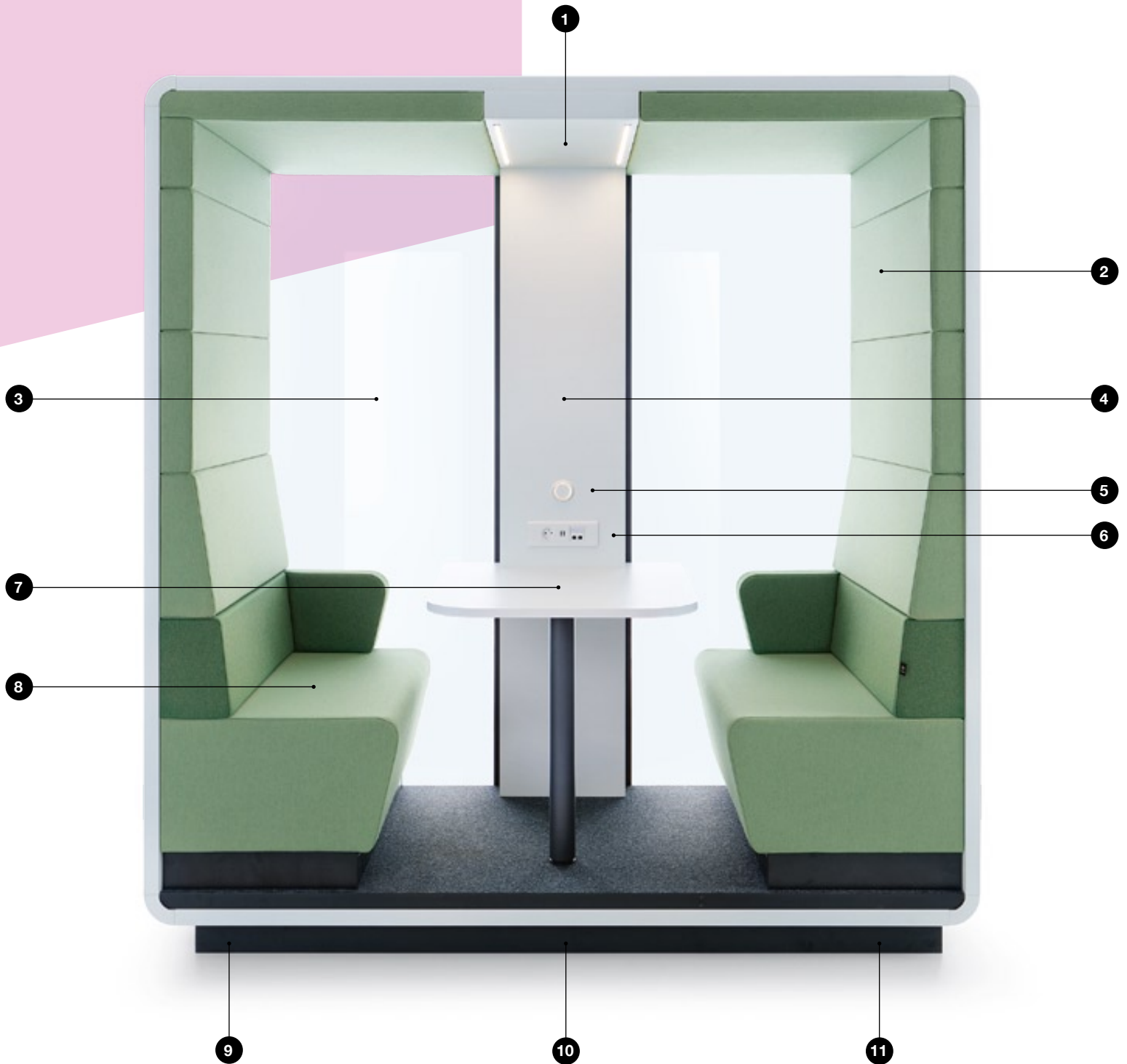



**WIDTH**  
2150 mm / 85 in

**HEIGHT**  
2300 mm / 91 in

**DEPTH**  
900 mm / 35 in

**WEIGHT**  
425 kg / 937 lbs



Up to  
two people



- 1 Led ceiling light with dimmer
- 2 Acoustic lined fabric panels
- 3 Laminated back acoustic glass panels
- 4 Option to hang a TV screen on the central panel
- 5 Independent, manual smooth lighting rotary knob
- 6 Power module (230V + USB + RJ45)
- 7 Compact desk
- 8 Two upholstered benches
- 9 Leveling feet
- 10 Removable front panel for pallet jack
- 11 Optional – seismic floor provision



# HUSHMEET.OPEN

TECHNICAL  
FEATURES





**WIDTH**  
2150 mm / 85 in

**HEIGHT**  
2300 mm / 91 in

**DEPTH**  
1390 mm / 55 in

**WEIGHT**  
550 kg / 1212 lbs



Up to  
four people



1 Led ceiling light with dimmer

2 Acoustic lined fabric panels

3 Option to hang a TV screen  
on the central panel

4 Laminated back acoustic  
glass panels

5 Independent, manual smooth  
lighting rotary knob

6 Power module  
(230V + USB + RJ45)

7 Compact desk

8 Two upholstered benches

9 Leveling feet

10 Removable front panel  
for pallet jack

11 Optional – seismic floor  
provision

# POWER MODULE



**Multiple types  
of electricity**



**Plug & play**

Hush can be equipped with a power module, USB Type-A, USB Type-C, and RJ45.





# EFFICIENT VENTILATION AND LED CEILING LIGHT MOTION OR PRESENCE SENSOR ACTIVATED



**Efficient  
ventilation**



**Energy-efficient  
LED lighting**

The ventilation and lighting systems within hushPhone are motion-activated. Because all other pods are bigger, all other pods are activated by presence sensors. Both systems run only when the pod is in use, saving energy.

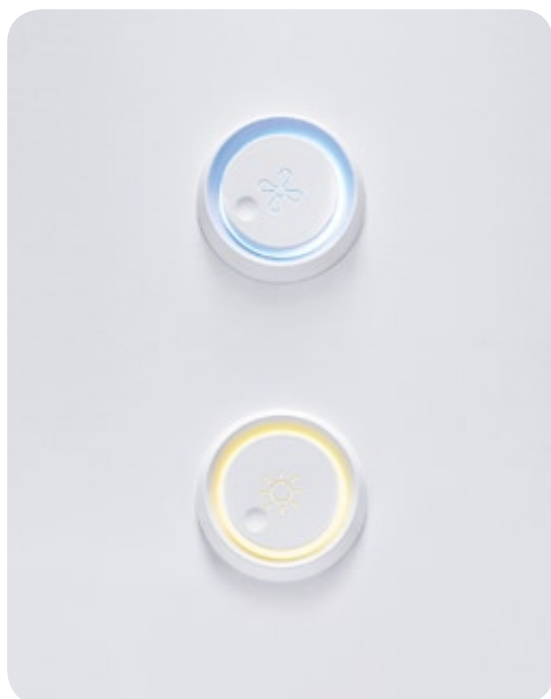

---

## LAMINATED GLASS WITH AN ACOUSTIC SEAL



### Anti-collision door marking

Prevents users from walking  
into the door when it's ajar.



## MULTIPLE FINISHES



### Multiple finishes

40 color options for the upholstery and 2 color options for the carcass; customize the product to complete the office space's aesthetic.

## HUSH FINISHES

More info on pages 116-117

28 colors  
Premium  
Wool

12 colors  
Petrus\*

\*not available  
in the US market

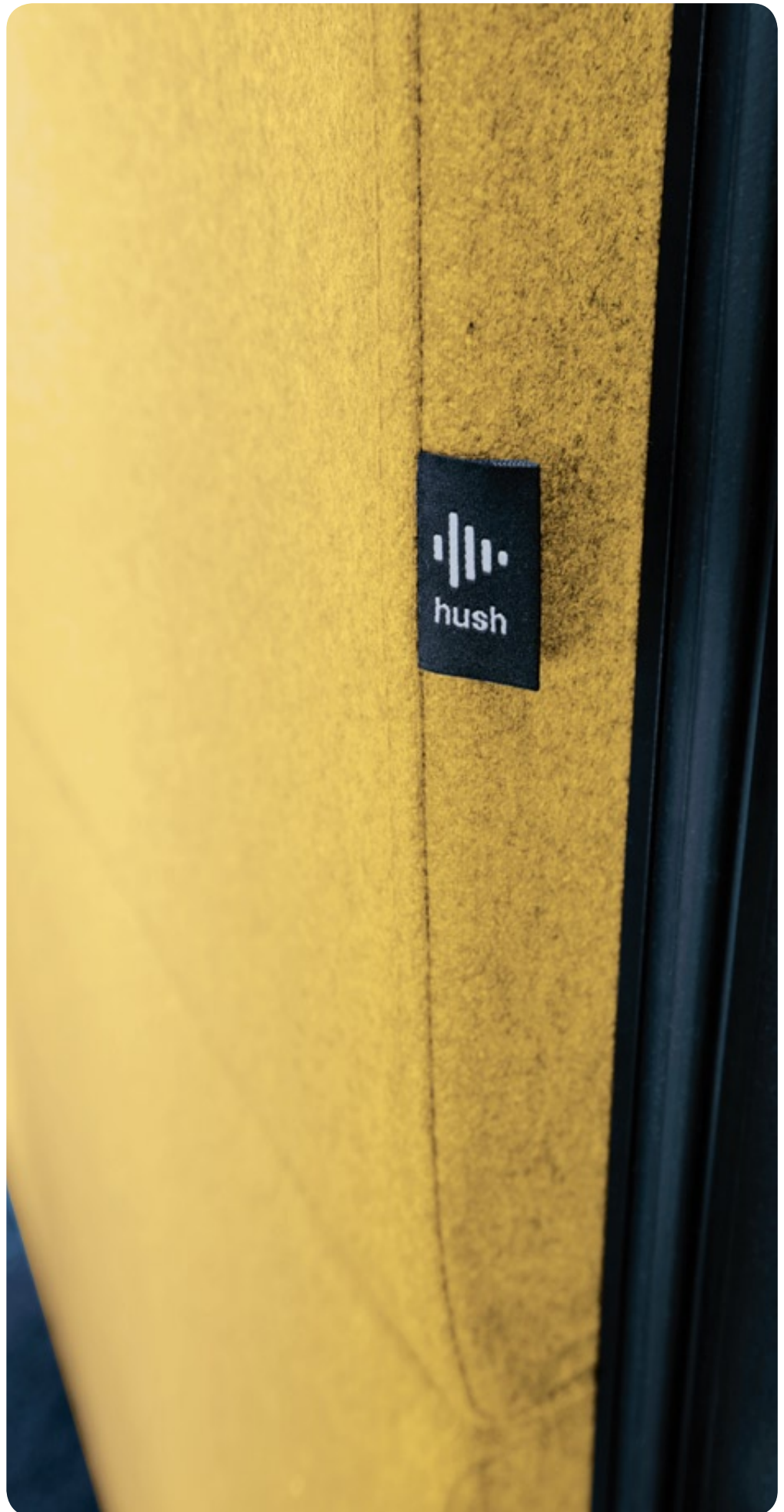

# HUSH FINISHES

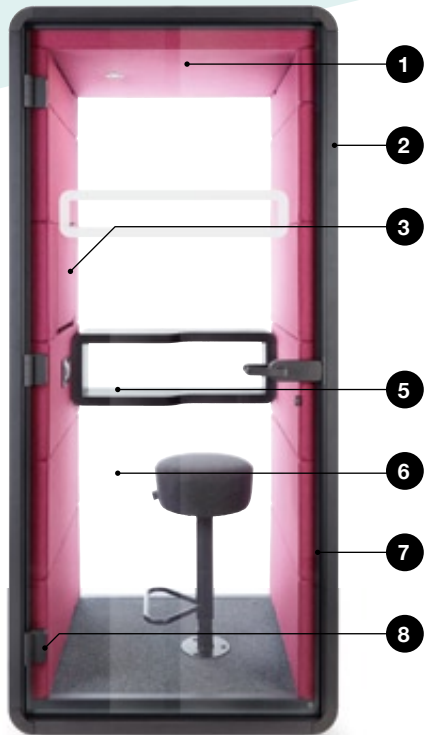

## 1 Interior



Upholstery  
Premium  
Wool



Upholstery  
Petrus\*



\*not available in the US market



2

Carcass



ABB White



AGC Cosmos Grey

3

Laptop table  
in hushPhone



MDN Natural Oak Veneer



AGA Velvet Grey



ABD Velvet White

4

Central  
column



ABB White



AGC Cosmos Grey

5

Shelf  
in hushPhone



JBM Lacquered White



JGC Lacquered  
Cosmos Grey

6

Rear  
glass



PRZ Clear



MGA Frosted

7

Aluminium  
profile



JGC Lacquered  
Cosmos Grey

8

Hinges /  
door handle



Anodized Aluminium



JGC Lacquered  
Cosmos Grey

Products  
available on



Experience Hush in any  
space of your choice  
Augmented reality mobile app





## CERTIFICATES & STANDARDS

Mikomax has operated for many years in compliance with the ISO 9001 management system standard. Hush products are delivered with the CE marking to prove compliance with the requirements for EC Declarations of Conformity. Mikomax strives for sustainability and is compliant with the ISO 14001 Environmental Management System standard. All components of Hush products have safety and flame-retardation certificates.



## FIRE SAFETY

Hush products may feature flame-retardant materials, including textiles, upholstery infill padding, outer panels and carpet liners. The Wool fabric used in Hush products is compliant with CAL 117, ASTM E84, BS 5852-0 and BS-EN 1021-1. Mikomax can provide products with BS 5852 compliant non-flammable foam. The non-flammability of carpet liners is certified per EN 1307:2014 and EN 14041:2008-05.



## WARRANTY CERTIFICATES AND TECHNICAL SUPPORT

Each Hush product has a 2-year warranty and comes with assembly instructions. All details of the warranty terms and conditions are provided in each Warranty Certificate. Mikomax provides technical support in assembly and installation by accredited installers and offers new user training courses.



Made in EU



**We are Mikomax Smart Office – the creators of the Hush product line. With 29 years serving an international market, we are experts at designing agile workplaces. Through each of these 29 years, we’ve analyzed global trends and best practices within offices all over the world. Why? To understand what people need. What we have learned is this: at each quarter, needs change. To keep up with this change, people need interior solutions that are flexible by design. So we leverage our specialty in office furniture production to manufacture products that are flexible on the next level. Products like Hush: acoustic pods that keep up with change.**

**Our passion is to provide people with workplaces that support their needs. We believe flexible, ergonomic solutions complete an office space and positively shape a team’s culture forever.**



**hush**

**mikomax**  
smart office.